



振华缝纫零件总汇
金振进出口有限公司
金振智能科技有限公司

JINZHEN IMPORT & EXPORT CO.,LTD.

Add: No.828-832 Sewing machine market Hulu
DongYang Zhejiang CHINA
浙江省东阳市虎鹿缝配城828-832
Tel: 0086-579-8615 0008 8615 2008
Fax: 0086-579-8615 1368 8615 2273
E-mail: zhenhua@jinzen.cc
Http: www.jinzen.cc



微信公众号: JINZENCHINA

JINZEN®
One-stop solution
缝配服务一站式采购

加盟专线:

☎ 400-622-0008

定价: 人民币398.00元

JINZEN®

2020

JINZEN®

Since 1983

2020

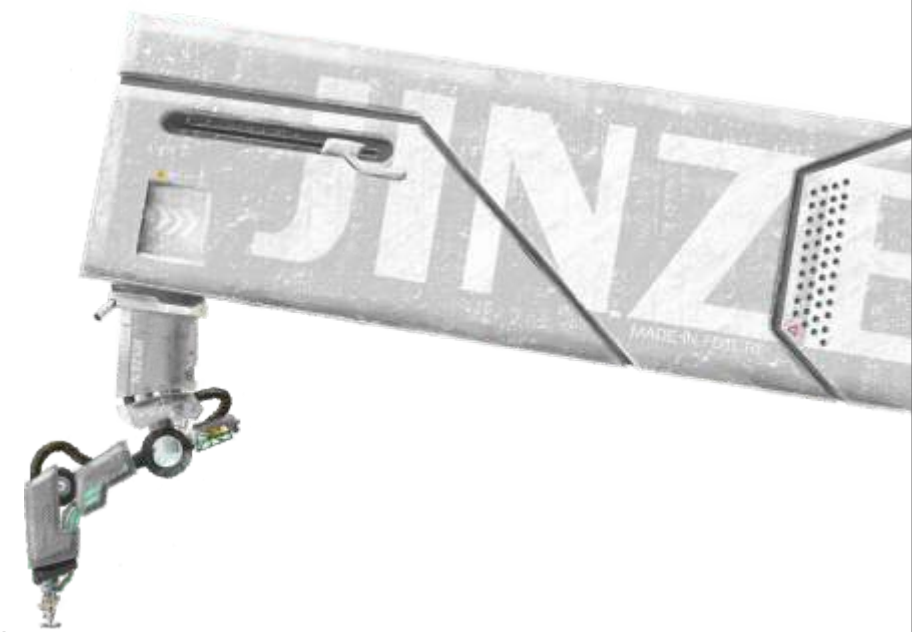

The future manufacturing
未来制造



雨田品牌策划

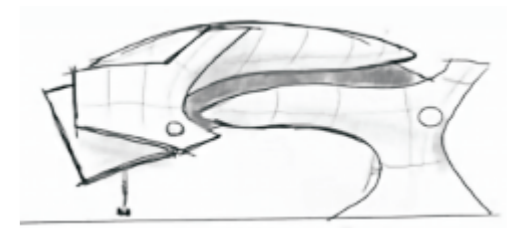

CARING FOR THE EARTH
LOW-CARBON LIFE
爱护地球 低碳生活

Jinzen brand,
always perfusion green theme
Follow the mission to protect the earth
Advocate for a better life and contribute to green

金振品牌
时刻灌注绿色主题
遵循爱护地球的企业使命
为倡导绿色美好生活而贡献

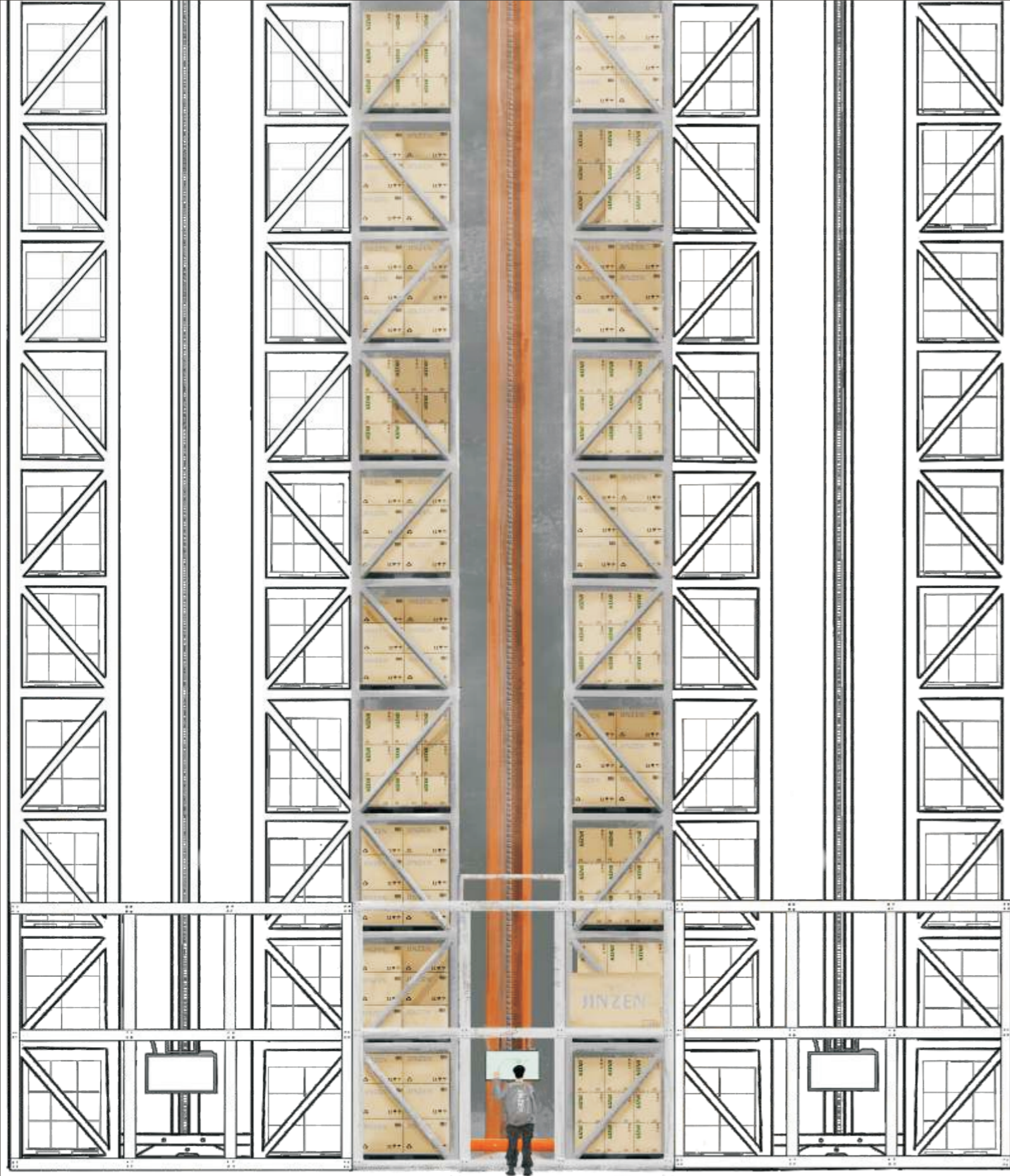

SEWING MACHINE SPARE PARTS

JINZEN®
One-stop solution
缝配服务一站式采购

San Car

縫配智能服務
spare parts with intelligent services



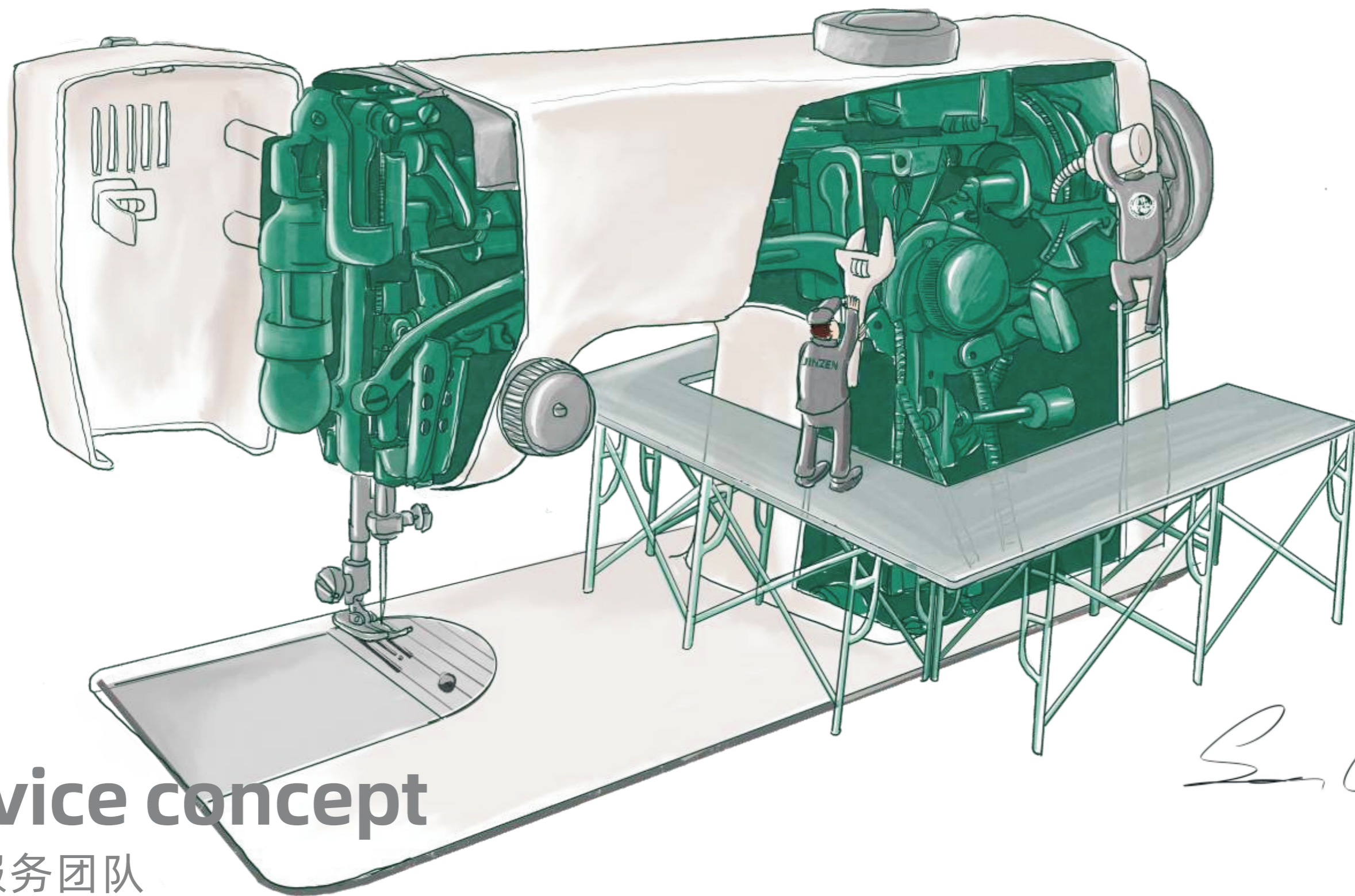

Service concept

专业服务团队

Sun Car

Algeria 阿尔及利亚
 America 美国
 Arab 阿拉伯
 Bengal 孟加拉
 Brazil 巴西
 Britain 英国
 Bulgaria 保加利亚
 Cambodia 柬埔寨
 Canada 加拿大
 Chile 智利
 Columbia 哥伦比亚
 Egypt 埃及
 El Salvador 萨尔瓦多
 Ethiopia 埃塞俄比亚
 Fiji 斐济
 Germany 德国
 Ghana 加纳
 Guatemala 危地马拉
 Hungary 匈牙利
 India 印度
 Indonesia 印度尼西亚
 Iran 伊朗
 Israel 以色列
 Italy 意大利
 Japan 日本
 Jordan 约旦
 Kazakhstan 哈萨克斯坦
 Kenya 肯尼亚
 Kuwait 科威特
 Kyrgyzstan 吉尔吉斯斯坦
 Malaysia 马来西亚
 Mauritius 毛里求斯
 Mexico 墨西哥
 Moldova 摩尔多瓦
 Morocco 摩洛哥
 Myanmar 缅甸
 Nicaragua 尼加拉瓜
 Nigeria 尼日利亚

Pakistan 巴基斯坦
 Paraguay 巴拉圭
 Peru 秘鲁
 Philippines 菲律宾
 Poland 波兰
 Portugal 葡萄牙
 Qatar 卡塔尔
 Republic of Uzbekistan 乌兹别克斯坦
 Romania 罗马尼亚
 Russia 俄罗斯
 South Africa 南非
 South Korea 韩国
 Spain 西班牙
 Sri Lanka 斯里兰卡
 Syrian 叙利亚
 Taiwan 台湾
 Tanzania 坦桑尼亚
 Thailand 泰国
 Tunisia 突尼斯
 Turkey 土耳其
 Ukraine 乌克兰
 Venezuela 委内瑞拉
 Vietnam 越南
 Yemen 也门
 Zimbabwe 津巴布韦



JINZEN®

Recruiting Global Brand Distributors

诚招区域代理商

The company was founded in 1983, focusing on sewing machine accessories and auxiliary equipment. Now it has more than 50,000 kinds of 8 series of JINZEN brand products, the products are exported to more than 5,000 customers in more than 50 countries and regions, and there are more than 1,000 strategic supporting partner factories, serving global garment and sewing manufacturers. In 2017, we installed the first intelligent storage system in the industry. We are the director unit of China sewing machine association, the rotating President unit of China sewing machine association parts branch, and a class A tax paying enterprise. In 2019, JINZEN intelligent technology factory completes the initial construction and gradually builds an intelligent sewing and matching industry chain, creating the concept of "future sewing service" with advanced consciousness.

公司创立于1983年，专注于缝纫机配件及辅助设备；现拥有金振品牌产品8大系列5万多种；产品远销50多个国家和地区5000余家客户，战略配套合伙人工厂有1000多家；服务全球服装及缝制制造工厂。2017年应用智能仓储系统，是中国缝制机械协会理事单位、中国缝制机械协会零部件分会轮值会长单位、A级纳税企业。2019金振智能科技工厂完成初步建设，逐步打造全智能缝配产业链，以超前意识打造了“未来缝配服务”理念！

Since 1983
JINZEN[®]
金振智能科技有限公司

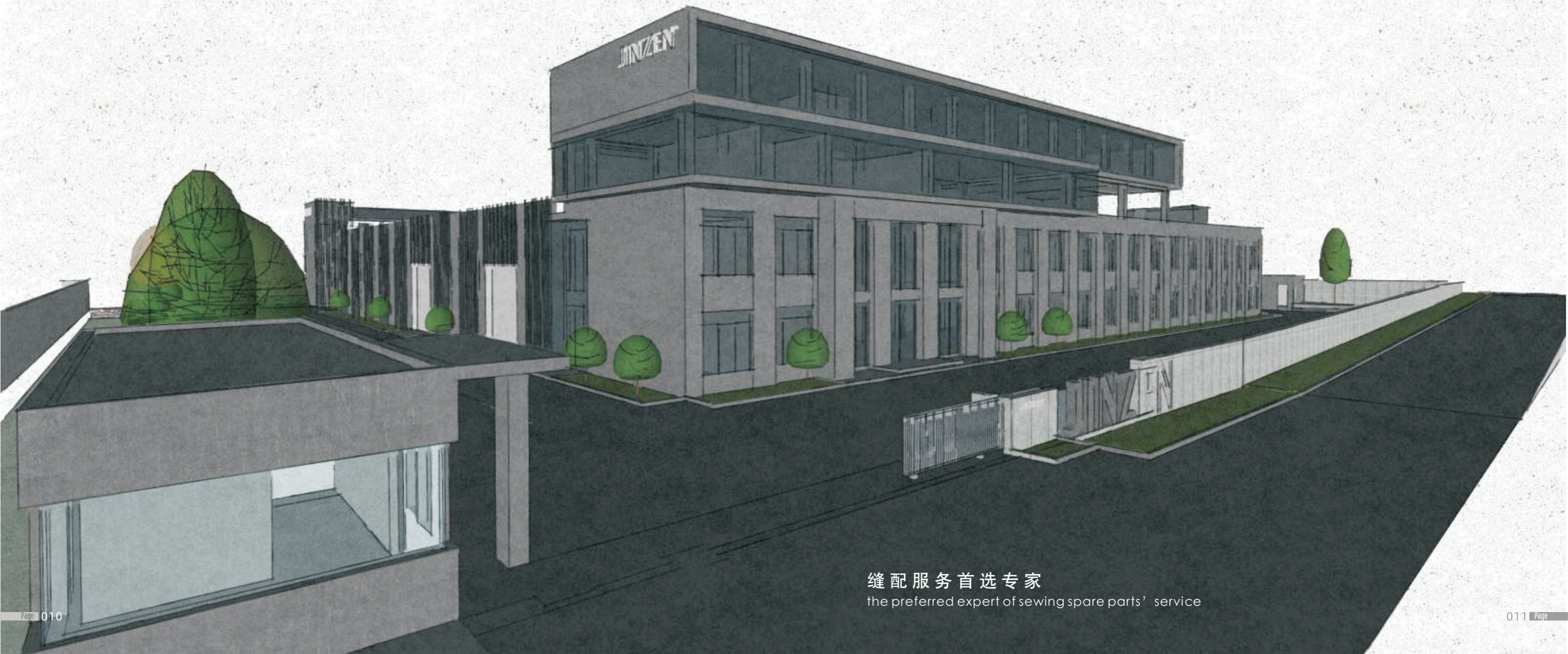

缝配服务首选专家
the preferred expert of sewing spare parts' service

JINZEN®

- P014 金振旋梭 JINZEN HOOKS
- P021 金振梭壳 JINZEN BOBBIN CASES
- P026 金振摆梭 JINZEN SHUTTLE HOOKS
- P029 金振梭心 JINZEN BOBBINS
- P032 金振刀具 JINZEN KNIFES
- P048 金振机针 JINZEN NEEDLE
- P050 金振针板 JINZEN NEEDLE PLATES
- P058 金振针位 JINZEN GAUGE SET
- P072 金振送布牙 JINZEN FEED DOG
- P076 金振弯针 JINZEN LOOPERS
- P090 金振针夹 JINZEN NEEDLE CLAMP
- P093 金振压脚 JINZEN PRESSER FOOT

- P108 夹线器组件 THREAD TENSION ASM
- P112 打褶器, 定规 ATTACHMENT & GAUGE
- P114 计数器平扣立扣 COUNTER PINGKOULIKOU
- P116 金振卷边筒 JINZEN FOLDER
- P134 套结机拖板, 压脚 FEED PLATE & WORK CLAMP
- P141 各类针杆 NEEDLE BAR

JUKI

- P152 重机 JUKI 1850
- P154 重机 JUKI 1900/1903
- P156 重机 JUKI 781
- P159 重机 JUKI 373
- P162 重机 JUKI DDL9000
- P164 重机 JUKI 380
- P166 重机 JUKI 1190
- P168 重机 JUKI 2280
- P171 重机 JUKI 271/391
- P172 重机 JUKI MO2516
- P174 重机 JUKI MO3600
- P176 重机 JUKI MO3300
- P178 重机 JUKI 7700/7800
- P182 重机 JUKI 8700
- P184 重机 JUKI 522
- P185 重机 JUKI 3168
- P186 重机 JUKI 515
- P187 重机 JUKI 1790
- P190 重机 JUKI 210D

brother

- P192 兄弟 BROTHER 101/735
- P194 兄弟 BROTHER 7200
- P196 兄弟 BROTHER 430
- P198 兄弟 BROTHER 430D
- P200 兄弟 BROTHER 814
- P203 兄弟 BROTHER 845
- P204 兄弟 BROTHER 917
- P206 兄弟 BROTHER 927/928
- P210 兄弟 BROTHER 9810/9820
- P212 兄弟 BROTHER 531/551
- P213 兄弟 BROTHER N31/HE800A

PEGASUS

- P215 飞马 PEGASUS M800
- P216 飞马 PEGASUS M600
- P218 飞马 PEGASUS M700
- P220 飞马 PEGASUS W500
- P222 飞马 PEGASUS W664
- P224 飞马 PEGASUS EX3200/5100
- 飞马 PEGASUS MX3200

SIRUBA

- P227 银箭 SIRUBA VC008
- P228 银箭 SIRUBA F007/C007
- P230 银箭 SIRUBA 747/757
- P232 银箭 SIRUBA 988

Kingtex

- P234 宝狮 KINGTEX SH7000

KANSAI

- P236 关西 KASAI 1404
- P238 关西 KASAI 1508
- P239 关西 KASAI 33 针

Yamato

- P240 大和 YAMATO AZ8500
- P242 大和 YAMATO 1500
- P244 大和 YAMATO 1500/2500
- P246 大和 YAMATO 2500/2700
- 大和 YAMATO VG3721
- P248 大和 YAMATO 四针六线

SHING LING

- P250 星菱 SHING LING 777
- P252 星菱 SHING LING SL700

DÜRKOPP

- P254 杜克普 DURKOPP 558

SINGER

- P256 胜家 SINGER 20U

NEWLONG

- P258 牛郎 NEWLONG NP-7

PFAFF

- P259 百福 PFAFF 335

- P260 高头车 810/820
- P262 罗拉车 591
- P264 罗拉车 9901
- P265 标准 TYPICAL341
- P266 标准 TYPICAL0302/0318
- P268 精工 8B/ 胜家 SINGER591
- P269 削皮机 801
- P270 伊士曼 EASTMAN
- P272 电裁剪 KM
- P274 断布机零件
- P275 圆刀 / 电剪 RS-100/ RS-90
- P276 胶订机 ST9000
- P278 家用机 JA1-1/JA2-2
- P280 多功能 307
- P282 胜家 SINGER974
- P284 兄弟多功能 BROTHER 5500
- P286 真善美 JANOME 2049
- P288 暗缝机 / 大白扣 / 修边机
- P289 杰克
- P290 家用多功能压脚 Sewing Machine Feet & Accessory For Household

JINZEN®

- P298 金振喷枪, 配件 JINZEN GUN & PARTS
- P300 熨斗, 配件, 熨斗靴 IRON & SHOES
- P314 喷漆 PAINT FOR MACHINE
- P315 标枪, 胶针 TAGGIN GUN & NEEDLE PIN
- P318 剪刀 SCISSORS
- P324 工作灯 MACHINE LIGHT
- P328 工具附件 TOOLS & ATTACHMENT
- P344 皮带罩 BELT COVER
- P346 门板组件 FRONT COVER ASM
- P348 护眼组件 EYE COVER
- P350 挑线杆, 油盘, 线架 THREAD STAND
- P358 电裁剪 CUTTING MACHINE
- P366 拖轮系列 PULLER ATTACHMENT
- P374 成衣剪线机 THREAD TRIMMER
- P386 台湾拖轮 PULLER ATTACHMENT
- P406 金振企业文化 The enterprise culture

温馨提示:

画册的编号解释: JZ代表JINZEN的第一个拼音字母, 数字代表序号, 金振样本中的序号从10001 10002 10003 依次从小到大的顺序排列, 考虑到以后会有增加新的配件或机型, 所以在不同的种类或机型后留有空号码, 由此带来的不便敬请谅解。

Warm tips:



Number explanation for this Catalogue: JZ stand for the first phonetic alphabet of JINZEN, Figure stand for the serial number. The serial number of 10001, 10002, 10003 in the JINZEN catalogue turn from small to large order, taking into account that we will have to add new accessories or models, so we remain empty after the number for different types and models, so please understand the inconvenience as the result.

 <p>JZ-10001 DB1-Z16 KR24 7.24mm</p> <p>For: BROTHER LE2-B861-1. JUKI LZ-27.29.40.271.403 MEIJA G15-2 ADLER 199.289.489 CONSEW 133A.825 SUNSTAR KLZ-371 UNICORN LZ2-H272 (needle slot:16mm)</p>	 <p>JZ-10002 HSH-7.94A(MTQ) KHS12-RY 7.94mm</p> <p>For: TAJIMA TME.TMEF.TMLE ETC BUTTERFLY GY4-1 TYPICAL GYD20-6 YINGLUN GY101-1 SUNSTAR SWF/A-WE1218-T1201 (small hook)</p>	 <p>JZ-10017 HSM-A1 KHS20-RTB 7.94mm</p> <p>For: TYPICAL GC6-9.GC6-10 (extra heavy materials.thick lines)</p>	 <p>JZ-10018 HSH-21-40(J) KRT21-J 8.01mm</p> <p>For: JUKI LH-512.-512-3.515</p>
 <p>JZ-10003 DB1-Z16B KR24-B 7.24mm</p> <p>For: BROTHER TZ1-B651.B652 BAS-400.LE2-B861-7 I-SIAN IS-335 KING'S HC-335 MILLION SPECIAL MS-335 TAKING TK-652 YULUN YLM-335 (needle slot:16mm)</p>	 <p>JZ-10004 HSH-7.94A(M1QTS) KHS12-RYNW 7.94mm</p> <p>For: BARUDAN BEMR.BEMS.BEMX (small hook.teflon base)</p>	 <p>JZ-10019 HSM-A1 KHS20-RTB 7.94mm</p> <p>For: BROTHER DB2-B745-7.B797.B797-5 TAJIMA TMB-E.TMB-W.TMW JUKI DDL-201S (heavy materials) TYPICAL GC6-7</p>	 <p>JZ-10020 HSH-21-40(AJ) KRT21-R 8.01mm</p> <p>For: JUKI LH-512H.515H (heavy materials) (short gib)</p>
 <p>JZ-10005 DB1-Z(20) KR24-U 7.24mm</p> <p>For: SINGER 20U.20U13.23 KERDER KD-20U PANDA(JIANN LIAN) JU-20U SIROKUMA LM-600 (needle slot:18mm)</p>	 <p>JZ-10006 HSH-7.94ATR(MTQ) KHS12-RYP 7.94mm</p> <p>For: TAJIMA TMBE.TME.TME-D TMFD-C.TMFX-C TMLE.TMLG. (Small hook) (under trimming machine)</p>	 <p>JZ-10021 HSM-ATR(1Q) KHS12-RYPN 7.94mm</p> <p>For: TYPICAL GC2603 GC2605</p>	 <p>JZ-10022 HSH-31 KRT31-R 7.93mm</p> <p>For: SINGER 21W180.46W61.47W62.63 52W30.31.131W CONSEW 228.228-11.228R-1.11 229.229R.229R-1.238.238-1 282.282R-1.289R-1.358R-1</p>
 <p>JZ-10007 HSH-7.94A KHS12-R 7.94mm</p> <p>For: BROTHER DB2-B706-5.B714-5.B755-5 JANOME DB-J705.706 MITSUBISHI DB-130-12.13.130G-12. 130G-127.DY-340-12 SINGER 391U.400W.402W.451K. NITAKA TC-1553.1555 NAKAJIMA DSN178-3</p>	 <p>JZ-10008 HSH-7.94ATR(MTQTS) KHS12-RYPN 7.94mm</p> <p>For: TAJIMA TMBE.TME.TME-D TMFD-C.TMFX-C TMLE.TMLG. (Small hook.teflon base) (under trimming machine)</p>	 <p>JZ-10023 HSM-ATR(1Q) KHS12-RYPN 7.94mm</p> <p>For: BROTHER BAS-412.416.423</p>	 <p>JZ-10024 HSH-31(B) KRT31-11S 7.93mm</p> <p>For: SEIKO CW-1.7.7B.8.8B.8V.8BV SINGER 47W70.131W CONSEW 207.223.223R.223R-1.227.382. 382R.388.388R-1.389.389R-1 (full gib)</p>
 <p>JZ-10009 HSH-7.94BG KHS12-S 7.94mm</p> <p>For: BROTHER DB2-B714-3.B753.B795-013 JUKI DDL-127.227.541.555.5550 MITSUBISHI DB-126-10.130G-10.171 LS2-1130-M.MOB-150-MOB SINGER 281-81.83.366.400W 600W TOYOTA AD148.156.345.352.D146.347.352 JANOME DB-J701~4.J707~8 (gold base)</p>	 <p>JZ-10010 HPF-134/ZSK KHS12-S 7.24mm</p>	 <p>JZ-10025 HPF-335 KHS12-S 7.24mm</p> <p>For: PFAFF 138.234.331.333.335.337-734</p>	 <p>JZ-10026 HSH-31(6) KRT31-NR 7.93mm</p> <p>For: YAKUMO 981.982 GOLDEN WHEEL CS-810.820 NITAKA TC-810S.820S SUNSTAR KM-867.KPW-827B</p>
 <p>JZ-10011 HSH-7.94B KHS12-S 7.94mm</p> <p>For: BROTHER DB2-B714-3.B753.B795-013 JUKI DDL-127.227.541.555.5550 MITSUBISHI DB-126-10.130G-10.171 LS2-1130-M.MOB-150-MOB SINGER 281-81.83.366.400W 600W TOYOTA AD148.156.345.352.D146.347.352 JANOME DB-J701~4.J707~8</p>	 <p>JZ-10012 HSM-A(MQTS) KHS20-RYN 7.94mm</p> <p>For: TAJIMA 6-7TS TMFD-C.TMFX-C TMLE.TMLG. (Large hook.teflon base)</p>	 <p>JZ-10027 HPF-335(5) KR69-V 7.24mm</p> <p>For: SEIKO LSC-8B.8BV CONSEW 277R.277RFS</p>	 <p>JZ-10028 HPF-390 KRT390G 7.925mm</p> <p>For: PFAFF 390</p>
 <p>JZ-10013 HSH-7.94ATR KHS12-RP 7.94mm</p> <p>For: ABLE HB-300 CHUAN NENG CN-991.992</p>	 <p>JZ-10014 HSM-ATR(MTQTS) KHS20-RYPN 7.94mm</p> <p>For: TAJIMA 6-7TRTS TMFD-C.TMFX-C TMLE.TMLG. (Large hook.teflon base) (under trimming machine)</p>	 <p>JZ-10029 HPF-490 KRT470-S 7.92mm</p> <p>For: PFAFF 471~493 SEIKO PWB-22GW-8W</p>	 <p>JZ-10030 KRT341-NR 341HR 7.93mm</p> <p>HYM-341AY For: JUKI 21229752W/GAP LS-341N MITSUBISHI LY3-6840-BOT GOLDEN WHEEL CS-8233-NR,8243</p>
 <p>JZ-10015 HSH-7.94BTR KHS12-SP 7.94mm</p> <p>For: JANOME DB-J709 JUKI DDL-500.DLD-432-2.DMN-530 TOYOTA AD157-623.-666.AD157A-622 CONSEW 290RATCW.290RTC.290RTCW ABLE HBS-2700 SUNSTAR KM-235A NAKAJIMA 178Y-2</p>	 <p>JZ-10016 HSM-B1H KHS20-GTB 7.94mm</p> <p>For: BROTHER DB2-B745-5 JUKI DDL-201H MITSUBISHI DY330-22D.337-2S ABLE HB-380 TYPICAL GC6-5</p>	 <p>JZ-10031 HPF-490(A) KRT470-R 7.92mm</p> <p>For: PFAFF 471~493 SEIKO PWB-8GW (short gib)</p>	 <p>JZ-10032 DP2-NJ KRP41-LH 7.94mm</p> <p>For: JUKI LBH-761.762.763 DALIAN G13 HUANAN(SOUTH CHINA) G16-1 SHANGGONG G15 SUNGOOD GF11001</p>

<p>JZ-10033 DP2-NJ771 KRP771</p>  <p>7.94mm</p> <p>For: JUKI LBH-771-774.781-784 K-CHANCE KBH-890 TAKING TK-888 DALIAN G18</p>	<p>JZ-10034 HSH-12-15L KRT12-5B</p>  <p>9.52mm</p> <p>For: BROTHER LT2-831-1.3B832-1.3B833 SEIKO LTW-26.27.27B.27BM NITAKA TC2-B842 SUNSTAR KM2-740B</p>
---	---

<p>JZ-10035 DP2-LB KRP41-B</p>  <p>7.93mm</p> <p>For: BROTHER LH4-B814</p>	<p>JZ-10036 HSH-12-15L(H) KRT12-5BHR</p>  <p>9.52mm</p> <p>For: BROTHER LT2-B831-5.B832-5 (heavy materials)</p>
--	---

<p>JZ-10037 DP2 KRP41-S</p>  <p>7.93mm</p> <p>For: PEGASUS DPS-2.3.150 YAMATO DP2.3 SINGER 107G.107W1.107W5.17 ADLER 91.98 DURKOPP 252.253.254.255.264 SUNSTAR DPK-2</p>	<p>JZ-10038 HSH-12-15LC KRT12-5BK</p>  <p>9.52mm</p> <p>For: BROTHER LT2-B835-3.5.800 SEIKO LTW-27BK CONSEW 327R-1 (corner sewing machine)</p>
---	--

<p>JZ-10039 DP2-815</p>  <p>7.94mm</p> <p>For: BROTHER LH4-B815 BAS-500</p>	<p>JZ-10040 HG12-15L(TRI)</p>  <p>9.52mm</p> <p>For: BROTHER LT2-B842 (under trimming machine)</p>
--	---

<p>JZ-10041 DP2-57(2) KRP 457</p>  <p>7.94mm</p> <p>For: MITSUBISHI LZ720-780 SINGER 457G YULUN 547U205.225</p>	<p>JZ-10042 HG12-15L(H) KRT842H-S</p>  <p>9.52mm</p> <p>For: BROTHER LT2-B841-5.B842-5 (heavy materials)</p>
---	--

<p>JZ-10043 DP2-57(2LP) KRP457-W</p>  <p>7.94mm</p> <p>For: SINGER 457G YULUN 547U435L (long hook point)</p>	<p>JZ-10044 HG12-15LC KRT845BK</p>  <p>9.52mm</p> <p>For: BROTHER LT2-B845</p>
---	--

<p>JZ-10045 HSH-11-55 KRT11-5</p>  <p>9.52mm</p> <p>For: JUKI LU-53.55.562 SEIKO STW-6.7.7B.8.8B.8BV.8M.8BM.8V 8VM.8VP.8VPM.8BVP SINGER 111W155.156.211G155.156 211U165.166.211U365/6.211W151. 155 CONSEW 137.139R-1.224R-1.225VMG. 266RVM-1 (slotted shank)</p>	<p>JZ-10046-A 3568</p>  <p>For: JUKI 3568</p>
---	---

<p>JZ-10047 HSH-12-15 KRT12-5S</p>  <p>9.52mm</p> <p>For: JUKI LH-51.51-10 LH-516.517.518.LU-53-7.562A SINGER 112W115-139</p>	<p>JZ-10048 HSH-12-15M KRT12-5M</p>  <p>9.52mm</p> <p>For: MITSUBISHI DN-260.260-10 DN-265.265-10 LT2-220-M.2220M.220.2220.L UNICORN LT2-H320.H321 ABLE LT2-220ML</p>
--	---

<p>JZ-10049 HSH-12C KRT12-5MK</p>  <p>9.52mm</p> <p>For: MITSUBISHI DN-275-10.10K TAJIMA TMP-20 UNICORN LT2-H240-MOB (corner sewing machine)</p>	<p>JZ-10050 HSH-12-15MM KRT12-5LM</p>  <p>9.52mm</p> <p>For: MITSUBISHI DN260-22.262.265-22.267 LT2-220-B.220-BOB.2220-B 2220-BOB NITAKA TC-B872 ABLE LT2-220BF</p>
--	---



<p>JZ-10051 HSH-12(2) KRT12-5J</p>  <p>9.52mm</p> <p>For: JUKI LH-1152 SUNGOOD GC0501</p>	<p>JZ-10052 HSH-12MC KRT12-5LMK</p>  <p>9.52mm</p> <p>For: MITSUBISHI DN-275-20.LT2-240-B.2240-B NITAKA TC2-B875 SICAMA(TASICO)LT2-B875 UNICORN LT2-H240-BOB (corner sewing machine)</p>
--	---

<p>JZ-10053 HSH-12-15(2)TR KRT12-5JCI</p>  <p>9.52mm</p> <p>For: JUKI LH-1152-4.5 (under trimming machine)</p>	<p>JZ-10054 HSH-12-15MMJ KRT11-5LJS</p>  <p>9.52mm</p> <p>For: JUKI LU-563 (slotted shank)</p>
--	--

<p>JZ-10055 HSH-12-62C(L) KRT12-5JK3-L</p>  <p>9.52mm</p> <p>For: JUKI LH-1162 SICAMA(TASICO)SC-1162-5 (left hand)</p>	<p>JZ-10056 HSH-12-15MMJ(A) KRT11-5LJR</p>  <p>9.52mm</p> <p>For: JUKI LU-563-3.LUH-520 YAKUMO 481L.482L SINGER 212U539A.839A 211U567A.867A.211U867 EAGLE EA-156RB (short gib.slotted shank)</p>
--	--

<p>JZ-10057 HSH-12-62C(R) KRT12-5JK3-R</p>  <p>9.52mm</p> <p>For: JUKI LH-1162 SICAMA(TASICO)SC-1162-5 (right hand)</p>	<p>JZ-10058 HSH-12-15MM(5) KRT-LS2-R</p>  <p>9.52mm</p> <p>For: BROTHER LT2-B837 SEIKO LLW-7L.7BL.8L.8BL.LSW-6L 7L.7L-TA.LLWH-7L-TA 8L-TA.28BL-TA TOYOTA AD331L.331LP.332L.332LP CONSEW 244B.254B.255RB.333R.339R.</p>
--	---

<p>JZ-10059 HSH-12M-82C(L) KRT12-5LJK3-L</p>  <p>9.52mm</p> <p>For: JUKI LH-1182 SICAMA(TASICO)SC-1182-5 SHANGGONG GD8-7 (left hand)</p>	<p>JZ-10060 HSH-12-15MMB(5) KRT-LS2-S</p>  <p>9.52mm</p> <p>For: BROTHER LT2-B838 SEIKO LLW-27BL.27BL.28.28L.28BL LSW-27L.27BL.27BLM.28L. LTW-27BLM CONSEW 333B.333RB-1.339.RB-1. 333RBL-1 (full gib.slotted shank)</p>
--	---

















<p>JZ-10061 HSH-12M-82C(R) KRT12-5LJK3-R</p>  <p>9.52mm</p> <p>For: JUKI LH-1182 SICAMA(TASICO)SC-1182-5 SHANGGONG GD8-7 (right hand)</p>	<p>JZ-10062 HG12M(BR) KRT872L</p>  <p>9.52mm</p> <p>For: BROTHER LT2-B872</p>
---	---

<p>JZ-10063 HSH-12-15MM(V) KRT12-5LMC</p>  <p>9.52mm</p> <p>For: MITSUBISHI DU-100-22.105-22.107.120-22 122.125-22.127.LU2-400B 420-BOB.4400.4420 (slotted shank)</p>	<p>JZ-10064 HG12MC(1) KRT875LK</p>  <p>9.52mm</p> <p>For: BROTHER LT2-B875</p>
---	--

	JZ-10065	HPF-3114		JZ-10096	1.6倍	1.6 times the capacity
FOR: PFAFF 114,3114,3115						
	JZ-10067	DP2-NG(790)		JZ-10068	H12MC(2)	3188TR
FOR: JUKI LBH 1790			FOR: JUKI LH3178-7,3128-7,3188-7			
	JZ-10069	2290		JZ-10070	1720	
FOR: JUKI LZ 1280,2280 ,2290			JUKI GOLDENWHEEL CSL-1720			
	JZ-10071	818		JZ-10072	HPF-151	
FOR: JUKI 818			FOR: PFAFF 120,122,141-146,142-720, 151,175-196,191-196,871-893			
	JZ-10073	HPF-145		JZ-10074	HPF-591	
FOR: PFAFF 91-010850-91 W/O CA,141-146, 175-196,871-893			FOR: PFAFF 591			
	JZ-10075	HPF-1242		JZ-10076	HPF-545	
FOR: PFAFF 91-140539-91 W/O CAP, 1242-720,1244-748			FOR: PFAFF 541-546,551-555,591-596, 542-720(large capacity hook,full.gib)			
	JZ-10077	241		JZ-10078	6-30	
FOR: FENG YING FY-241-246-246V			FOR: TYPICAL GC6-30			
	JZ-10079			JZ-10081	380	HSM-B(SU) KHS20-GTVG
FOR: TYPICAL GC6-20			FOR: SUNSTAR KM-380BL			

	JZ-10082	557	KRT211-L		JZ-10097	484	3倍	3 times the capacity
HSH-12-15MM(S) FOR: SINGER 211G557,558,556, 211U566,211G*104, 106,109,114,117, 212G539,541, 212G*2,106,114 (large capacity hook)								
	JZ-10084		HPF-1242TR		JZ-10085	KRT545-S	HPF-545(B)	
FOR: PFAFF 1242-720,1244-748				FOR: PFAFF 541-546,551-555 591-596,544-720				
	JZ-10086		KPT341-NH		JZ-10088	KRT19-R	HSH-19	
FOR: NITAKA TC-341-L TC8370L,8371L,8372L, 8872L,9510L,9511L,6520L				FOR: SINGER 110W-2,119W				
	JZ-10090	KRT8-BL	HSH-31MMB(S)		JZ-10120	HSH-7.94BOHNTR(B)		
FOR: SEIKO 13719 LCW-28BL,-8BL SUNSTAR KM-390BL								
	JZ-10121	768			JZ-10095	3823		
	JZ-10080	253	HSH-32		JZ-10092	132	KRT-132	
FOR: SEIKO SKM-26,36, SINGER 133K				FOR: MITSUBISHI MG23E0121 SEKIO 1343C SK-2B,-6,-6F SINGER 103123 132K CONSEW SK-6,-7,-8 DURKOPP ADLER 265-21-142 265 GOLDR WHEEL CS-6500,6501,CSL-1800,1801				
	JZ-10093	133			JZ-10094	132M	KRT-132-M	
HSH-33 KRT133 FOR: SEIKO 2530 CK-1 SINGER 103120 133K				FOR: SEIKO 1526 SKM-26,-36				

	JZ-10122 HPF-438		JZ-10123 HPF-418
	JZ-10124 HDU-271		JZ-10125 HSM-A(5)
	JZ-10126 245		JZ-10127 246
	JZ-10128 380 (小)		JZ-10129 D530-1
	JZ-10130 697		JZ-10131 592
	JZ-10132 HPF-591G		JZ-10133 HF-12MC(2)TR
	JZ-10134 HAD-167		JZ-10135 HF-12MM(2)TR
	JZ-10136 467TR		JZ-10137 HF-12MC(2)

	JZ-10301 BC-31-15		JZ-10302 BC-DBZ(3)-NBL (12mm Opening) For:ELTAC 750 series SINGER 20U TAJIMA
	JZ-10303 BC-LK(B2) With NBL-101 Spring For:BROTHER LK3-B430.-B431.-B432.-B433-B434 -B435.-B438.BAS-303~330 BAS-555		JZ-10304 BC-457(NS) For:CONSEW 347.375R.376R JUKI LZ-1285.-1286.-1287 MITSUBISHI LZ-720-11 BROTHER LZ2-B852.-853.-854 SINGER 457G.457U STAGER DZ-S31.SZ-310 TOYOTA AD550.A551
	JZ-10305 BC-LK(J3) For:JUKI AMS-210A.-12A.LK-1850		JZ-10306 BC-LBH771 For:JUKI LBH-771.-772.-773.-781~4
	JZ-10307 BC--DB1 For:ADLER.BROTHER.CONSEW. HUSQVARNA.JANOME.JUKI. MITSUBISHI.NECCHI.RICCAR. TOYOTA.YAKUMO.YASIMA SINGER 95.96.103.188U.195K.196K.245		JZ-10308 BC-DBM(1) For:BROTHER D82B745-7.B797-5 TAJIMA TMB-E.TMB-W.TMW JUKI DDL-201S YAKUMO DBU-175L-3 CHINA GC6-7
	JZ-10309 BC--DB1-NBL1 Whit NBL-1303 Spring For:ADLER.BROTHER.CONSEW. HUSQVARNA.JANOME.JUKI. MITSUBISHI.NECCHI.RICCAR. TOYOTA.YAKUMO.YASIMA SINGER 95.96.103.188U.195K.196K.245		JZ-10310 BC-DBM(1)NBL3 Whit NBL-1303 Spring For:BROTHER D82B745-7.B797-5 TAJIMA TMB-E.TMB-W.TMW JUKI DDL-201S YAKUMO DBU-175L-3 CHINA GC6-7
	JZ-10311 BC--DBZ (1) (18mm Opening) For:ADLER 199.289.489 BARUDAN.BROTHER TZ1.LE2.BAS-400 JUKI LZ(except-405.-407.-581.-582.-583 -586.-1280.-1286.-1287) NECCHI 533.535.720.721 STAGER DZ.SZ(except DZ-S31.SZ-21-1B -5.-310)		JZ-10312 BC-6-5 For:BROTHER DB2-B745-5 JUKI DDL-210H MITSUBISHI DB-325-22D.DY330-22D TOYOTA D530-130.140 YAKUMO DBU-175L-1/1.680L CHINA GC6-5.6-6.6-9
	JZ-10313 BC-DBM(2)-NBL1 HSM-A(5) Whit NBL- 241 Spring For:CONSEW 206RB.208RB JUKI DNU-241H SEIKO STH-3BL.-7BL.-8BL YAKUWMO 280L.880LM		JZ-10314 BC-PF9076(14) (14mm Opening) For:PFUFF 130.138.230.238.335 SEIKO LSC-8BVC
	JZ-10315 BC-DBM(Z2)-NBL For:TAJIMA		JZ-10316 CP-12C(835) For:BROTHER LT2-B835-3.5.800 JUKI LH-528 CONSEW 327R-1 TAJIMA TMP-20 ABLE HB-630 (corner sewing machine)



JZ-10317 BC-PF9076
 (9mm Opening)
 For: **PFAFF** 133.134.232.234.260.300.331.332
 333.341.343.360.432.433.434.437
 438.439.461.463.465.467.481.483
 485.487.489
SEIKO LSC-8B.-8BV
ADLER 069
CONSEW 277



JZ-10318 CP-G12C(845)
 For: **BROTHER** LT2-B845
SUNSTAR KM-490



JZ-10319 BC-HA1
 For: **SINGER** 15k88.90.91



JZ-10320 CP-62C(1162)
 For: **JUKI** LH-1162.1162-4.5
SICAMA(TASICO) SC-1162-5.6
 (whit bobbin thread control spring)



JZ-10322 CP-M82C(1182)
 For: **JUKI** LH-1182.1182-4.5
SICAMA(TASICO) SC-1182-5.6
 (large capacity cap with bobbin thread control spring)



JZ-10323 BC-107(2)-NBL 814
 With NBL-603 Spring.
 For: **ADLER.BROTHER.CONSEW.DURKOPP.**
JULI.MITSUBISHI.PEGASUS.YAMATO.
SINGER 107G.107W3.14.15.50.143W1.2.3.
 18.307G2.



JZ-10324 CP-G12MC(1)(875)
 For: **BROTHER** LT2B875
SUNSTAR KM-790-BL



JZ-10325 SC205H
 For: **JUKI** AMS220



JZ-10327 BC-310A
 For: **BROTHER**.BAS.-304.310.311.314.326.
 341.701
 (thin material)



JZ-10328 CP-HPF151(10159)
 For: **PFAFF**.151
GOLDEN WHEEL CS-861.862.8810.8820
YAKUMO 561-564



JZ-10330 BC-DBZ (1) -NBL6
 With NBL-406 Spring
 For: **ADLER** 199.289.489
BARUDAN.BROTHER TZ1.LE2.BAS-400
JUKI LZ(except-405.-407.-581.-582.-583
 -586.-1280.-1286.-1287)
NECCHI 533.535.720.721
STAGER DZ.SZ(except DZ-S31.SZ-21-1B
 -5.-310)



JZ-10331 BC-HZ3(NS)
 (12.3mm slot)
 With Ns tension spring
SINGER 307



JZ-10332 BC-DBZ(2)
 (18MM OPENING)
 FOR : **JUKI** LZ-586



JZ-10331-2 307 Two hole
SINGER 307



JZ-10334 LS-341
 For: **PFAFF** 1242-720B. C. D 1242-74B
 B. C. D 1244-720 B544-720 B. D.
 551-555 (S L) 551-553 (SL)



JZ-10335 BC-DBM(Z1)NBL3
 FOR: **CONSEW** 175. 176. **ELTAC** 900.1800
SERIES SZ-21-1B. -21-5
TOYOTA D530,-18E, -30P, -101, -110,-120
SEIKO LZH,EVL



JZ-10336 CP-M697
 FOR: **DURKOPP** 697



JZ-10337 181
 FOR: **MITSUBISHI** PLK-A1710



JZ-10338 CP-G12MC(1)TR
 S09280-001TR



JZ-10339 BC-DB1(G)
GOLD HANDER



JZ-10340 BC-PF3114
 FOR: **PFAFF** 144, 155, 116, 3114, 3116



JZ-10343 BC-9076(TG)-NBL6
PFAFF/DUPKOPP TYPE
 WITH NBL-806 SPRING
 FOR: **PFAFF**



JZ-10351 LH-1152
 FOR: **JUKI** LH-1152



JZ-10352 LH-527 CP-12MC
 FOR: **JUKI** LH-527,LUH-521,526,527
MITSUBISHI,
 DN-275-20,
CORNER SEWING MACHINE LIARGE
CAPACITY CAP



JZ-10353 LZ-2280
 FOR: LZ-2280 **GOLDEN WHEEL** S-2200



JZ-10354 LBH-790
 FOR: **JUKI** LBH-790 137-29769



JZ-10355 1.7倍大



JZ-10356 CP-HPF144TR
 FOR: **PFAFF**. 144
GOLDEN WHEEL CS-61118.T.BT
 CS-61128.T.BT
SEIKO PWB-8GWC.FLLC
SUNSTRA KM-867-7



JZ-10357 DDL-545
 FOR: **PFAFF**



JZ-10358 双丝机1720
 FOR: **SINGER**110W,118W,119W,236W,
GOLDEN WHEEL CSL-1720





JZ-10359 810内斧
 FOR: **HOOK** 810,820



JZ-10360 526
 FOR: **LU**-1565,LUH-521,LUH-526

	JZ-10364	210D	SC-180S	FOR: JUKI LK1910,1920,1930,AMS-210D		JZ-10365	SINGER 反向	125291	125291
	JZ-10367			FOR:BC-DB1-NBL6 SPRING BC-DB1-8		JZ-10368			
	JZ-10369	BC-1306		SPS-B1306		JZ-10371	3倍	BC-HST(2)	FOR:JUKI LK-1941 3 times the capacity
	JZ-10374		BC-DBM(22)-NBL3	BC-DBM(Z2)-NBL3 WITH NBL FOR:TAJIMA		JZ-10378	845TR	CP-G12C-TR	FOR:BROTHER LT2-B845
	JZ-10380		BC-6-5-NBL	BC-DBM-NBL3 WITH NBL FOR:BROTHER DB2-B745-5 JUKI DDL-210H		JZ-10381		BC-457-NBL	
	JZ-10382		BC-LBH771-NBL	WITH NBL FOR:JUKI LBH-771,-772, -773,-781-4		JZ-10383	591		
	JZ-10384		BC-NJ380			JZ-10385	245	CP-M245	DMN-530-4 B1837 041 OAO
	JZ-10386	761	BC-107(2)	FOR:JUKI LBH761-763		JZ-10389	1.6倍		1.6 times the capacity

	JZ-10390	168				JZ-10391	2600大斧		
	JZ-10392	2600摆梭				JZ-10393	588大斧		
	JZ-10394	588摆梭				JZ-10395	3823		
	JZ-10396			开袋机梭壳 (大)		JZ-10397			开袋机梭壳 (小)

严格通过近20多道程序检测，在抗耐磨，防卡线，间隙小，低噪音上表现出的品质尤为突出。

为此我们郑重承诺：凡购买后3个月内出现的质量问题包退包换。

JINZEN hook has passed through 20 detections, and have these outstanding advantages, such as wear resistance, avoiding the thread winded, small gap, low voice.

Hereby we make a solemn commitment that all

JINZEN products sold on approval if any quality problems in 3 months.

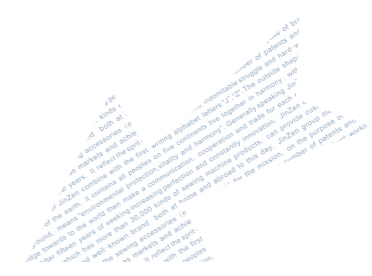



JINZEN 梭



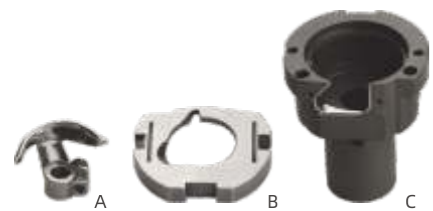

JZ-10801 1850



JZ-10802 1900



JZ-10803 MITSUBISHI
2520



JZ-10804 430D



JZ-10805 1900A



JZ-10806 210D

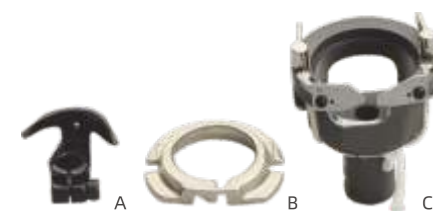

JZ-10807 430



JZ-10808 430E小孔8.0



JZ-10809 311EL



JZ-10810 430E大孔9.6



JZ-10811 430F



JZ-10812 430D小孔8.0



JZ-10813 SUNSTAR



JZ-10814 MITSUBISHI
A1006

JINZEN®

JINZEN® BOBBINS



JA1-1



974



136492



163131



506417



JZ-10901 Singer



JZ-10902 JANOME



312954



3129565

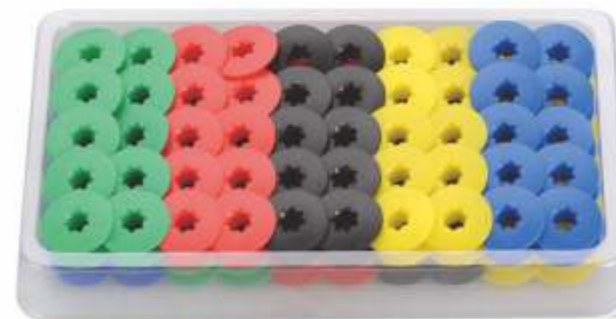

JZ-10903 Plastic



JZ-10904 AL

JINZEN[®] BOBBINS



272152A



272152L



203470A



B1809-761-000A



18034A-B



50006-03



杜克普 ϕ 22 26 32mm
0246003058



40264A



272152Y



10079A



146025-001(814)



18034A



B1805-205-000
(1900A)



3823



591



55623A



272152G



B1827-280-000
(2996A)



B1811-771-000A



515665-001
(430D)



138-12102
(210D)



400-66272 开袋机



233939



55623AS



272152R



9033A



771Y



155484-001(1182)



3倍 (3TIMS)



9910



1.6倍 (1.6TIMS)



272152A2



272152B



91-174480



771B



509285-001(1182 3孔)



400-22188



270010



40264



55623



172222



55623-H



18034



155484-001



GA5-1



270010S



40264B



55623S



112781-101



55623S-H



18034B



263099



204



270010S-深



2996A



55623B



9033



270010S-H



B9117-201-000



150971-001-4



GB4-1



40264NS



20518



10079



203470



270010-H



B9117-563-000



150971-001-2



5810



2518



40264(2HG)-H



1.6倍 (1.6TIMS)



203470B



18034-H



B9117-563-00-B



S00871-1



97949



JZ-11201
other size can be manufactured
可订制各种规格

JINZEN® BAND KNIFE
JINZEN STRAIGHT KNIFE AVAILABLE SIZE

2200mm	2450mm	2800mm	2950mm	3000mm	3460mm
3500mm	3550mm	3555mm	3600mm	3650mm	3680mm
3700mm	3850mm	3860mm	3920mm	3960mm	4000mm
4050mm	4120mm	4150mm	4220mm	4250mm	4350mm
4450mm	4460mm	4500mm	4550mm	4560mm	4630mm
4760mm	4720mm	4870mm	4920mm	4950mm	5280mm
5360mm	5420mm	5480mm	5500mm	5650mm	5940mm

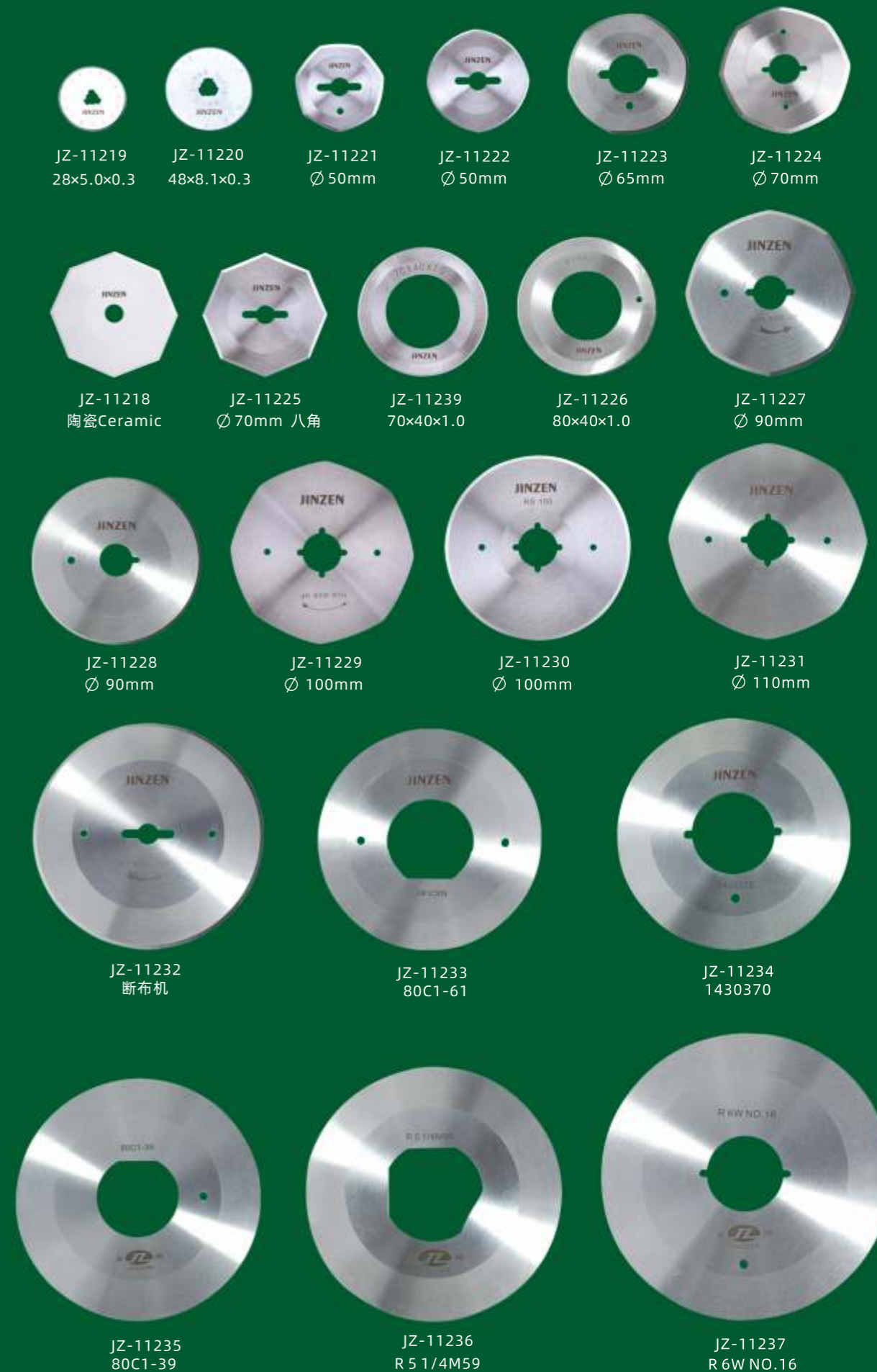

JINZEN®

来自台湾的品质
Quality from Taiwan



AAAAA

高速钢

AAA

合金钢

采用进口SKS7、M2高速钢以及SK2合金钢，
采用目前最先进的生产工艺流程，配套有国内顶级的热处理设备，
目前品种已达上千种，每个通过高精度检测影像仪器严格检测。

JINZEN knife Use imported SKS7 M2 high speed steel and SK2 alloy,
with the most advanced production processes, top domestic heat treatment equipments,
and so far already have more than 1000 types.
Each knife has inspected under high-precision detective imaging device.



JZ-11300 合金钢

- 1/4
- 5/16
- 3/8
- 7/16
- 1/2
- 9/16
- 5/8
- 3/4
- 7/8
- 1"
- 1-1/8
- 1-3/16
- 1-3/8
- 1-1/2



JZ-11302 高速钢

JZ-58085 AAA



JZ-11301 AAAAA



5E 6E



JZ-11308 5E 6E 7E 8E 9E 10E 12E 13E AAAAA
JZ-11309 5EW 6EW 7EW 8EW 9EW 10EW 12EW 13EW AAAAA



JZ-11304



JZ-11305

JZ-11305 SIZE: 5E 6E 7E 8E 9E 10E 12E 13E AAA

JZ-11304 SIZE: 5EW 6EW 7EW 8EW 9EW 10EW 12EW 13EW AAA



JZ-11306

JINZEN®



有一种力量叫

品牌

多年来，

不管市场环境如何变化，

金振的产品总是随着市场应运而生。

除了质量、工艺之外，

不可否认，更离不开金振人的热情服务！





CR26 CRL 103 C007J 425/6-4 111114-0-01 111113-0-01 B2421-210-000 B2421-210-AA0



象王/金轮高头车固定刀 SA3335-001 SB1191-001 0271-001497 JZ-11351 548848 D2713 SB0598-001



MF-40A1834 MG4080834 MF-40A1835 MG4080835 0271-001483 MF-40A2180



179459-05 S03627-001 JZ-11352 S001701-0-01 JZ-11353 179458-05 S07525-000



40015996 301006 MAT-022040000 RU10 110-42652 D2408-555-CA0



SA6989-001 S37672-101 S37671-101 S37675-101 S37676-101 32020505



13-1241-377-0A0 S49988-001 MS03B0838 HV270080 FX0206010000DD FX0227000000 SA3330-101



110-95403 400-25949 G5409-254-000 141509-101 S19824-001 S50404-301

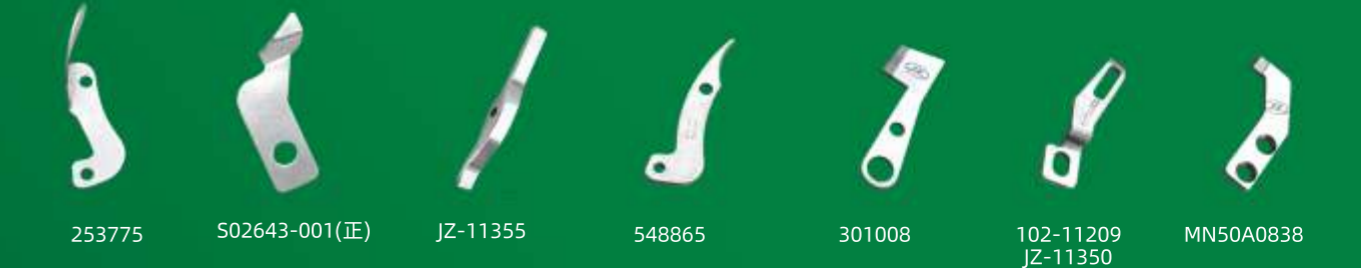

253775 S02643-001(正) JZ-11355 548865 301008 102-11209 JZ-11350 MN50A0838



MG52A0838 MF02A0838 A-B2111417-556 10-001A-2700 716-154468-0-01 181LY-B110522020 S02637-001



MG52A0834 MF02A0834 154575-0-01 MF00A0834 S02646-001 S02645-001



91-264240-05 2111417-553-A 2111407-553-B 02520172-145-A-B 10-106A-2700 KM-250 181LY-B115421010

OUR QUALITY, YOUR TRUST

JINZEN®







JZ-11402



JZ-11401



Glove Size	Size Number	Color Code	Traditional Glove Size	Hand Circumference
XXS	00	Brown	5 - 5.5	127 mm
XS	0	Green	6 - 6.5	152 mm
S	1	White	7 - 7.5	178 mm
M	2	Red	8 - 8.5	203 mm
L	3	Blue	9 - 9.5	229 mm
XL	4	Orange	10 - 10.5	254 mm

CE 5-FINGER GLOVES COMPLY EN1082
UL LISTED 73P8 SAFETY GLOVE



JINZEN®
 SINCE 1988

Chain Mail Protective Gloves

Glove Type

Resistant Left Right

Three Finger with palm strip

Five Finger, anti-tear

Five Finger with _____ inch / centimeter safety cuff

Super construction

Strap / Cuff Style

Elastic Polyester / Nylon

Spring Stainless steel

Rubberized Non-slip

Size Information

X-Small / Green X-Small / Green

Small / Green Small / Green

Large / Green Large / Green

Special



JZ-11422



JZ-11423



JZ-11424



JZ-11425



JZ-11426



JZ-11427



JZ-11428



JZ-11429



JZ-11430



JZ-11431

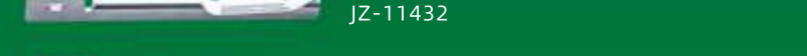

JZ-11432



JZ-11433



JZ-11421



JZ-11434

- 71 1/8
- 71 1/4
- 71 5/16
- 71 3/8
- 71 7/16
- 71 1/2
- 71 9/16
- 71 5/8
- 71 11/16
- 71 3/4
- 71 13/16
- 71 7/8
- 71 15/16
- 71 1
- 71 1-1/16
- 71 1-1/8
- 71 1-3/16
- 71 1-1/4
- 71 1-3/8
- 71 1-1/2



JZ-11435



JZ-11436



JZ-11437



JZ-11438



JZ-11439



JZ-11440



JZ-11441



JZ-11448



JZ-11449



JZ-11450



JZ-11452



JZ-11442



JZ-11443



JZ-11445



JZ-11446



JZ-11447



JZ-11452



JZ-11500

JINZEN® High quality Needle

机针型号:

用途:

- DB×1 ----- 平车 lock stitch
- DB×K5 ----- 绣花机 embroidery stitch
- DP×5(135×5) ----- 锁眼及曲折缝机 buttonholing ,zig-zag sewing
- DC×1 ----- 包缝机 overlock
- DC×1NS ----- 包缝防起皱 overlock for new synthetic material
- DC×1KN ----- 包缝针织布料 overlock for knitted fabric
- DC×27 (B27) ----- 高速包缝 highspeed overlock
- DP×17(135×17) ----- 厚料机 lock stitch for thicker material
- UY×128GAS (DV×43) ----- 绷缝 2-3needles double chain stitch
- DV×1(UY121GS) ----- 绷缝 2needles double chain stitch
- TQ×1 ----- 钉扣 button sewing
- TQ×7 ----- 钉扣 button sewing
- TV×7 ----- 镶边/折缝 hemming ,felled seam
- TV×5 ----- 折缝,felled seam
- UN×154 ----- 弯针包缝 curved overlock needle
- DM×13 ----- 安全缝纫 interlock
- DO×5 ----- 圆头锁眼机 eyelet buttonholing
- UO113GS ----- 橡筋车用 smocking ,double chain stitch
- LW×5T ----- 盲绕缝 blind stitch
- LW×6T ----- 折缝 盲缝 felled seam, blind stitch
- PF×134LR ----- 皮革用斜切刀针 45°
- SH×1 ----- 大型电绣机针 (蕾丝针) schiffli needle (for large automatic embroidery machine)
- SH×3 ----- 大型电绣机针 (蕾丝针) schiffli needle (for large automatic embroidery machine)
- SH×3TOP ----- 加长型 longer type of SH*3
- CP×12 ----- 珠边机 pin-point sewing
- HA×1 ----- 家用机针 for domestic sewing machine

SIZE:

55	60	65	70	75	80	85	90	100	110	120	125	130	140	160	180	200
7	8	9	10	11	12	13	14	16	18	19	20	21	22	23	24	25

JINZEN®



大鼻针
Crewels,
Plain Eyed

JZ-11501



JZ-11514



JZ-11515



JZ-11516



JZ-11517



JZ-11502



JZ-11503



JZ-11504



JZ-11505



JZ-11506



JZ-11507



JZ-11508



LISITE
JZ-11510



DAILY
JZ-11511



JZ-11513



G-B
JZ-11512

JINZEN®

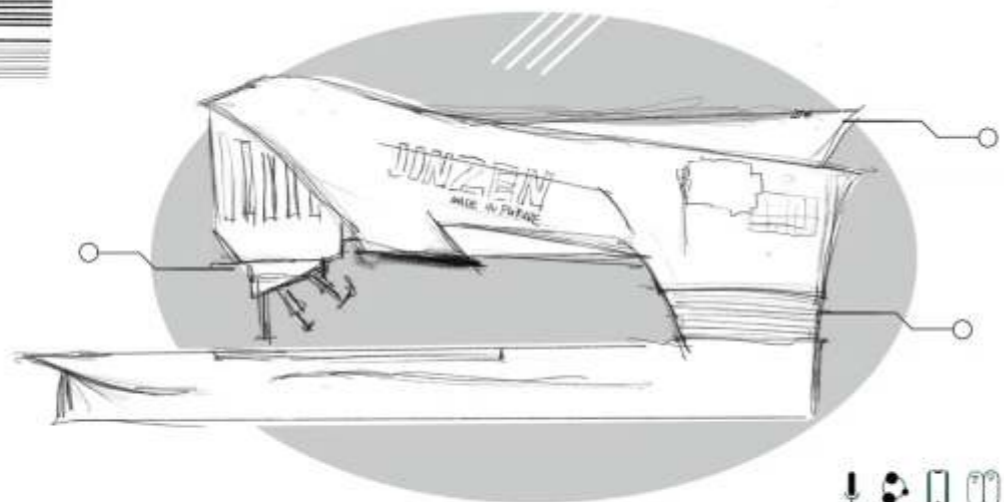
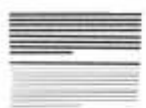

有一种传播叫口碑，口碑相传、永续经营中。
产品的口碑是金振企业得以发展壮大的基石。



JINZEN®

NEEDLE PLATE 针板









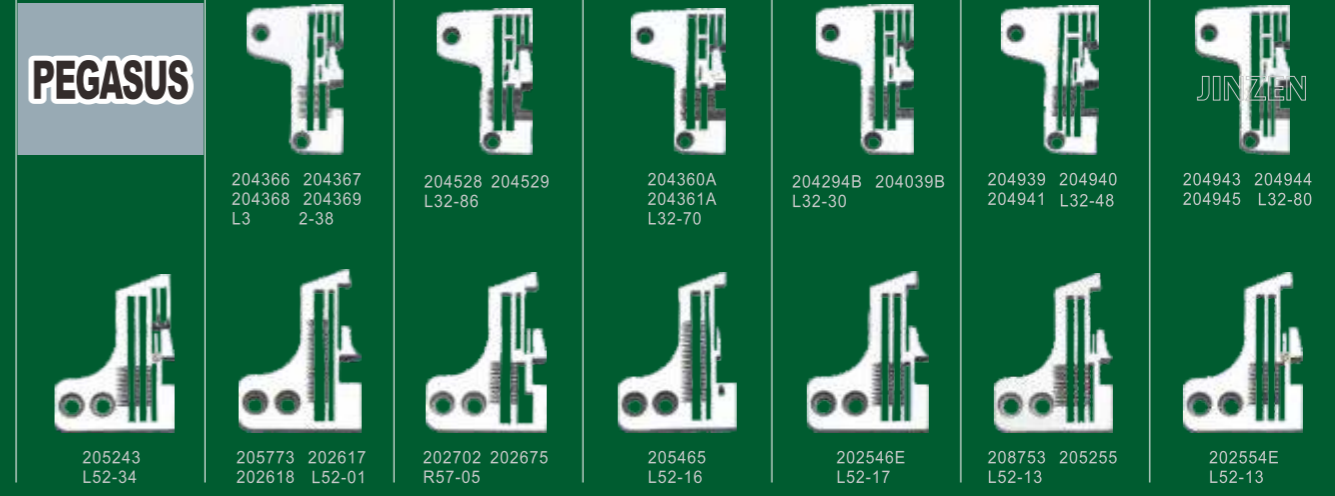



brother





















PEGASUS



 210783 210784 E52-211	 210796 210797 E52-130	 210799 210800 E52-130	 210804 210805 E52-132	 210809 210810 E52-131	 210837 210838 210839 E32-420	 210980 210981 210982 E32-542	 R4100HOACOO MO-2504	 R4200HODDOO R4305HOFDOO R4200HOFDOO MO-2504	 R4300HODEOO R4300HOFEOO MO-2504	 R4305HODEOO R4305HOFEOO MO-2514	 R4205HODEOO R4205HODEAO MO-2514	 R4206-HODEOO MO-2514	 R4308HODEOO R4308HOFEOO MO-2514
 210868 E32-451	 210986 210987 E32-542	 208674 208648	 208675 208676	 277500P40 277500P30 277500P50 Ex5204	 277512P15 277502P15 Ex5204	 277524T50 277524T60 EX3216H	 R4508HODDOO R4508HOEDOO R4508HOFDOO MO-2516	 R4608HODFOO MO-2516	 R4608HOFGOO MO-2516	 R4612HOFGOO R4612HOFBOO MO-2516	 R4608HODEOI	 R4612HODEOI MO-2516	 R4200JODDOO R4200JOEDOO R4200JOEDAO MO-3904
 277513R50 277513R40 Ex3216	 277516R60 277516R50 Ex3216	 277517R40 277517R50 Ex3216	 277505R40 277505R30 277505R50 Ex5214	 277519R40 Ex3244	 257015B32 257015B40 257015B48 257017B56 W561-01	 257016B48 W561-01	 R4300JOEEEO R4300JOFEOO MO-3904	 R4305JODEOO R4305JOFEOO MO-3914	 R4508JODDOO R4508JOEDOO R4508JOFDOO	 R4612JOEDOO R4612JOFDOO R4612JOFBOO MO-3916	 R4608JODDOO R4608JOEDOO R4608JOFDOO MO-3916	 R4608JOFDOO	 R4361FOGHOE R4361FOHFOE MF-890
 257018B56 257018B64 W561-01	 257018B56-N 257090C56 W561-01	 257018C56 W542-03	 257018D56 W561-03	 257090B56 W561-03	 257097B56 257097B64 N644-03	 257108B56 257108B64 W664-08	 B1137-352-000 MO-352	 B1136-357-A00 B1136-357-B00 B1136-357-C00 MO-357	 R4612LOFGOO MO-3316	 R4612LOHGOO MO-3316	 R4361FOGFOB R4361FOHFOB MF-870	 50324B5.6 MF-7407	 MS-1261 1/4
 206276 206277 W61-01	 257033B56 257033B64 W561-02	 257030B48 257032B56 257032B64 W561-02	 257050B40 W561-05	 257050B48 W561-05	 257053B56 257053B64 W561-05	 257102B56 257102B64 W664-35	 B2402-761-000 LBH-761	 B1190-522-SOO DLM-5200 1/8 B1190-522-TOO DLM-5200 3/16	 12422	 B1192-522-000 DLM-5200	 B2402-771-000 LBH-780	 B1103-380-DOO B1103-380-FOO1/4 MH-380	 MS-26 1/4
 R4300EOFEEO MO-804	 R4200EODCOO R4200EODDOA MO-804	 R4205EODEEO MO-814	 R4305EOFEEO R4305EODEEO R4305EODEOA MO-814	 R4508EODCOO MO-816	 R4608EOFGOO MO-816	 R4612EOFGOA MO-816	 14-8540 14-8640 W8003D	 14-8180 14-8190 W8003D	 14-763 14-764 DWK1802D	 14-889	 14-890 14-891	 14-845 14-847 W8103	 14-860 14-861 14-862 W8803C
 R4300EOFEEO MO-804	 R4308EODEEO MO-814	 R4200LOEEEO MO-3316	 R4300LOFEEO MO-3304	 R4305LOEEEO MO-3314	 R4508LOEGOO MO-3316	 R4608LOEGOO MO-3316	 14-896 14-897	 14-801 14-802 W8003C	 14-854C DWK1803D	 14-854D DWK1803D	 14-744B DVK-1702D	 14-855 14-865	 14-745B 14-753

JUKI

KANSAI

 14-858 14-868 DWK1803EMK	 14-746 14-756 14-766 DWK1802F	 14-856 14-866 DWK1803F	 14-728 14-738 14-748 14-756 14-768 Y7102EMK	 14-812 14-813	 14-811 14-814	 14-301 14-302 DPW-1302S			 34564 34565 34566 DCZ-503	 2048000	 32666 32667 DCE-200	 34893 34894 DCE-200	 32671 32673 32672 DCE-203	 33353 32678 dce-220W
 14-790 14-791	 14-784 14-785	 14-612	 14-760 14-760H B2000C	 14-5530 1503PHD	 14-5800 1508P 1/4X7/8X1/4	 14-5810 1508P 1/4X1X1/4	 35334 DCE-341	 34598 34585 DCE-520	 33541 36570 DCE-361	 33545 36590 DCE-361C	 Y21768 21769 Z5003	 Y21774 Z5003	 Y21781 Z5020	
		 E1826 E1827 FOO7E	 E1524 E1525 FOO7E	 E3826 E3826P E3827 E3827P COO7D	 E3524P E3525P COO7E	 E1828 FOO7E	 E2826P E2827P FOO7	 21787 Z5020	 Y21812 Y21813 Z6000	 Y2022 E6000	 2108000 2108001 HZ8000H	 2108002 AZ8003H	 2108003 AZ8003H	 2108006 2105014 AZ8020H
 E4326 E4326P E4327 E4327P COO7D	 E6326 E6327 FOO7E	 E2635D COO7D	 E2625P E2626P E2627P COO7E	 E4826 F007	 E4836M E4837M FOO7E	 E3626P COO7E	 2108006 2108014 AZ8020H	 2108013	 2108008B	 2108064 Az8000	 2108062	 2108050 2108051	 2108052 2108053 2108076	
 E589 E590 737	 E589F 737	 E591 E591A 747	 E591B 747	 E591E 747	 E591F 747	 E783 E784 737	 90166 90167 DW-100 DW-1350 94800 94801 94802	 93170 93171 93172 VF-2400	 3108133 3108134 3108135 VC-2700	 95260 95261 95262 DV-1409	 95278 95279 DW-1509	 3208096 3208097 VF-2539	 3208093 3208094 VF-2539	
 E796 E797 737	 E804 E805 747	 E809 E919 E810 E920 747	 E800 737	 E934 737	 E868 E870 757	 E868D E871 757	 94801C	 94801D Y3108134D DN-2500 VC-2700	 94801-N VF-2500 VC-2700	 94801B VF-2500	 Y3508003	 Y3508021	 3508019	
 E982 757	 E986 757	 E988 767	 E989 767	 E834 757	 E853 757	 E851 757	 Y3118023 256 Y3118024 264 Y3118025 356 VC-3711	 3508100	 3008025 VF-2503	 95234 VF-1403	 95085 VF-2503	 94210 94211 94212 VF-2403	 94281 90556 90557 VF-2403 DW-303	 91764 91765 94901 94901 94902 DW-103 DW-1353

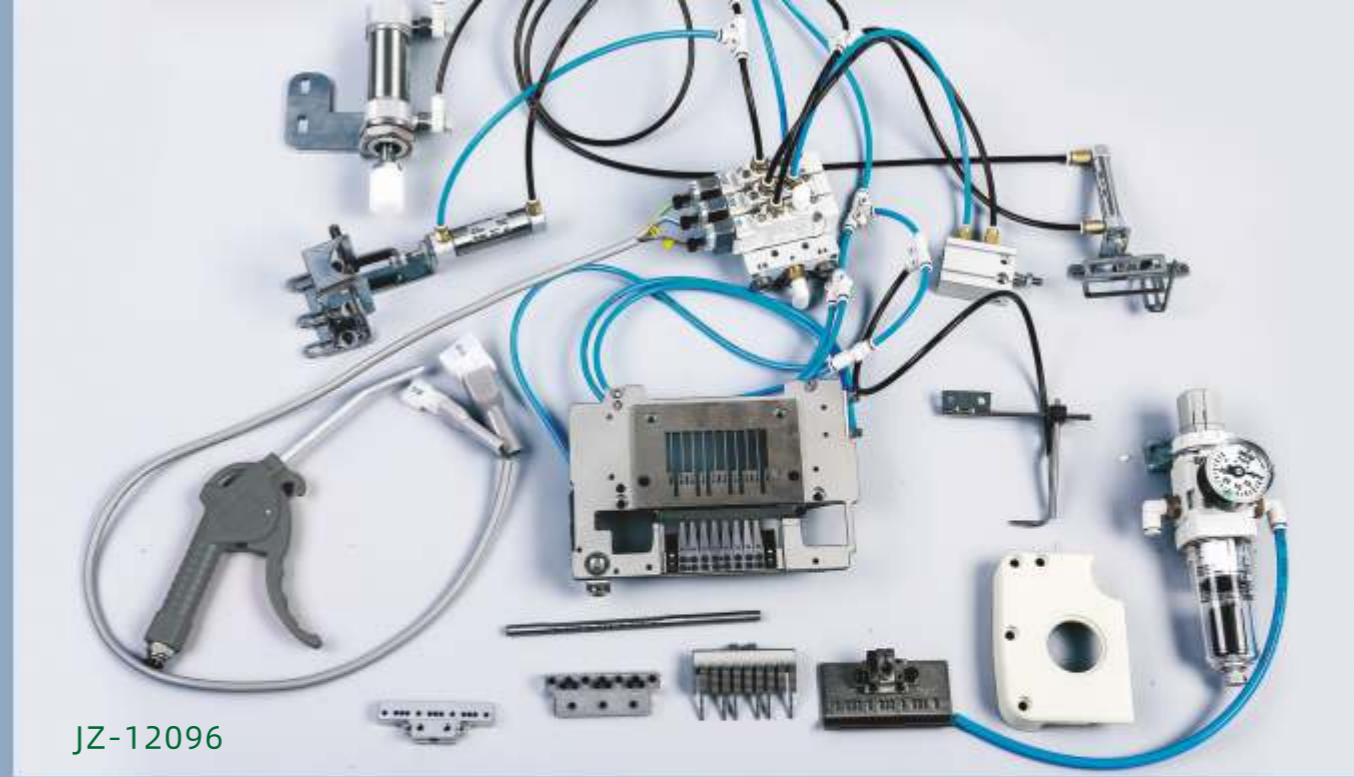
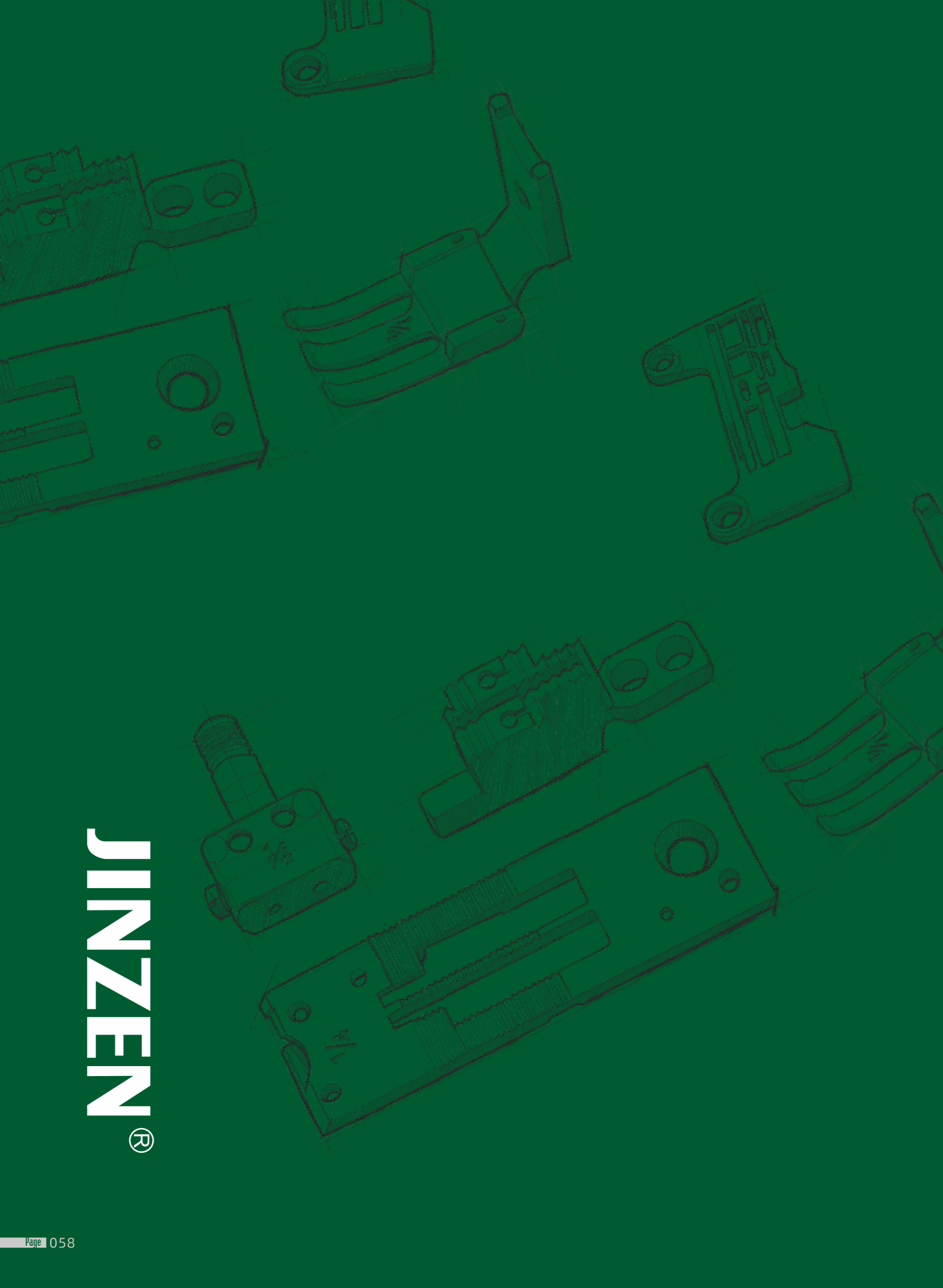

JZ-12096



JZ-12097



JZ-12098 1517 1-5/8



JZ-12099



JZ-12100 J1412 1/8X17H 牙带孔

JINZEN® GAUGE SET

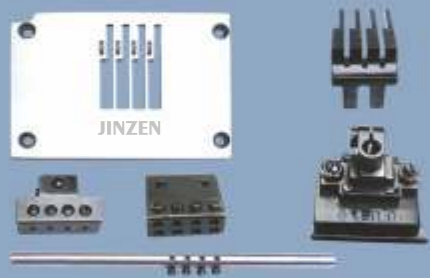

1404P 4N 1/4 3/16 5/16 3/8
1412P 4N 1/2 7/16 1/4 3/8
JZ-12101



1404/1412P 6N 1/4 3/16 5/16 3/8
JZ-12102



1404P 8N 1/4 3/16 5/16 3/8
1412P 8N 1/2 7/16 1/4 3/8
JZ-12103

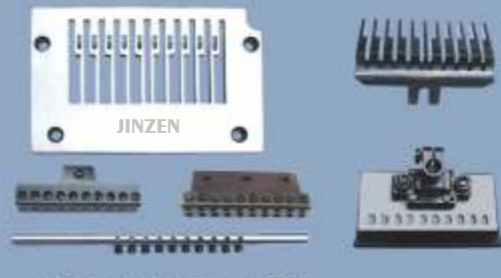

1404/1412P 10N 1/4 3/16
MH-380 1/8 5/32 3/16 7/32 1/4
5/16 3/8 1/2 5/8
JZ-12104



1404P 11N 3/16 1/8 1/4 3/8
1412P 11N 1/2 7/16 1/4 3/8
JZ-12105

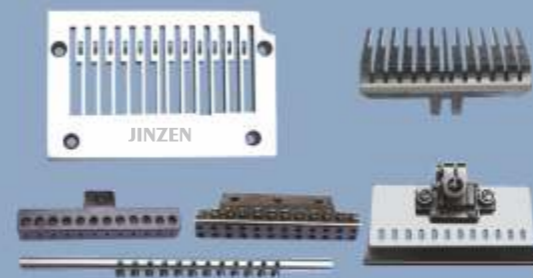

1404P 12N 3/16 1/8
1412P 12N 3/16 1/8 1/4
JZ-12106

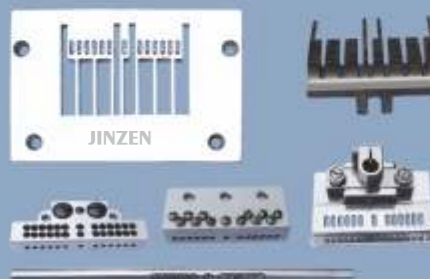

1412P 13N 1/8 3/16 1/4 3/8
JZ-12107

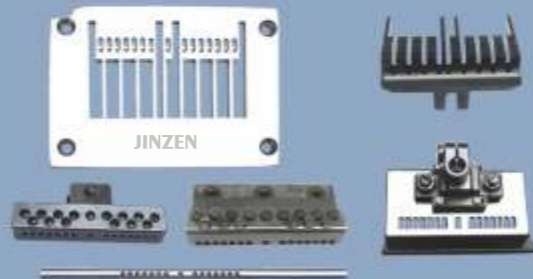

1404P 15N 1/8 3/16 1/4 3/8
1412P 15N 1/2 7/16 1/4 3/8
JZ-12108

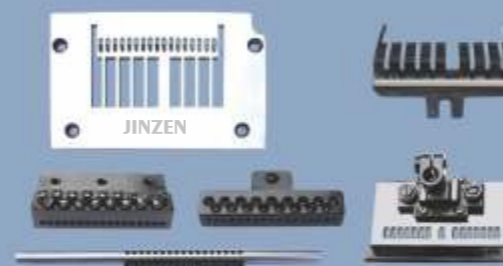

1404P 17N 1/8 3/16 1/4 3/8
JZ-12109

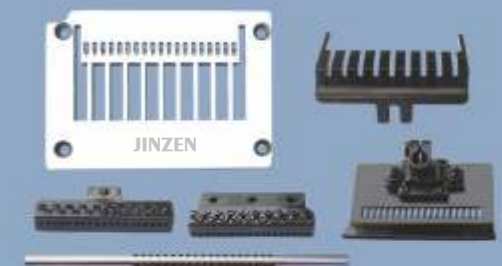

1412P 19N 1/8 3/16 1/4 3/8
JZ-12110

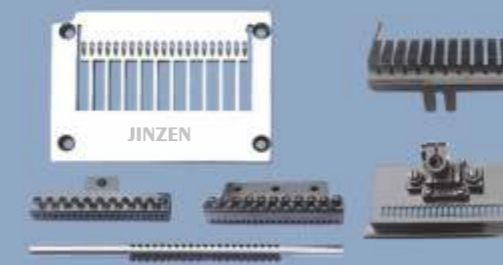

1412P 21N 1/8 3/16 1/4 3/8
JZ-12111

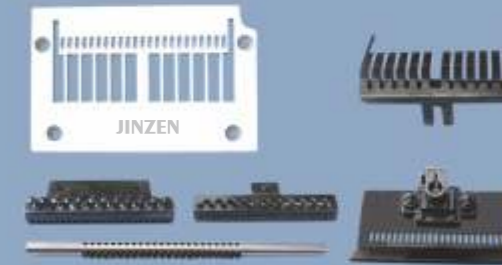

1412P 23N 1/8 3/16 1/4 3/8
JZ-12112

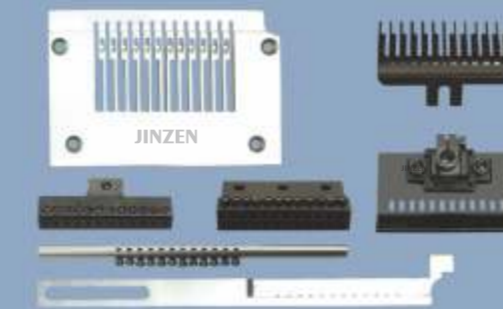

12N JZ-12113

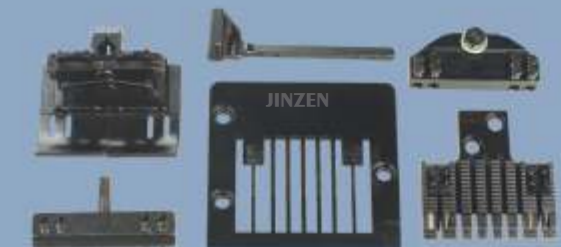

JUK I 1410 JZ-12114



1702 JZ-12117 1508P JZ-12115



33N JZ-12116



JZ-12120
KANSAI
7N 12N 16N 25N 33N

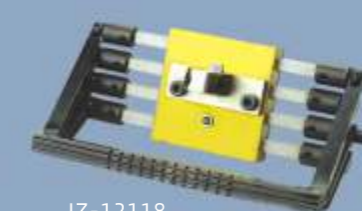

JZ-12118
SIRUBA
7N 12N 16N 打搅架

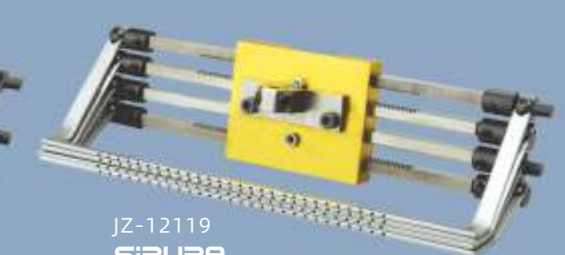

JZ-12119
SIRUBA
25N 33N 打搅架



JINZEN®
GAUGE SET
 HIGH QUALITY



JZ-12194 842-TR
 1/8 5/32 3/16 7/32 1/4 5/16
 3/8 5/8 1/2 3/4 7/8 1"



JZ-12195 3568-7
 1/8 5/32 3/16 7/32 1/4 5/16
 3/8 5/8 1/2 3/4 7/8 1"



JZ-12196 双针开门襟针位 1/4 3/16



JZ-12197 双针制帽针位 1.8MM 2.0MM



JZ-12224 假发针位组 4.0MM 4.8MM



JZ-12198 假发针位组



JZ-12199 双针模板机针位



JZ-12200 日星针位



LH515 (831)
 1/8 5/32 3/16 7/32 1/4 5/16
 3/8 5/8 1/2 3/4 7/8 1"
 JZ-12201



LH1162
 1/8 5/32 3/16 7/32 1/4 5/16
 3/8 5/8 1/2 3/4 7/8 1"
 JZ-12202



LT2-B845
 1/8 5/32 3/16 7/32 1/4 5/16
 3/8 5/8 1/2 3/4 7/8 1" 1/4
 JZ-12203



B845-TR
 1/8 5/32 3/16 7/32 1/4 5/16
 3/8 5/8 1/2 3/4 7/8 1"
 JZ-12204



LH3168
 1/8 5/32 3/16 7/32 1/4 5/16
 3/8 5/8 1/2 3/4 7/8 1"
 JZ-12205



LH3168-7
 1/8 5/32 3/16 7/32 1/4 5/16
 3/8 5/8 1/2 3/4 7/8 1"
 JZ-12206



GC20202
 1/8 5/32 3/16 7/32 1/4 5/16
 3/8 5/8 1/2 3/4 7/8 1"
 JZ-12207























21010
 1/8 5/32 3/16 7/32 1/4 5/16
 3/8 5/8 1/2 3/4 7/8 1"
 JZ-12208



双针切割针位组
 1/8 5/32 3/16 7/32 1/4 5/16
 3/8 5/8 1/2 3/4 7/8 1"
 JZ-12209



DU 针位
 1/8 5/32 3/16 7/32 1/4 5/16
 3/8 5/8 1/2 3/4 7/8 1"
 JZ-12210

JZ-12214 DT6-B927 6.4mm(1/4)	JZ-12227 DT6-B928 6.4mm(1/4)	JZ-12228 DT6-B928-7 3.2mm x2(1/8 x 2)	JZ-12229 DT6-B928-6 3.2mm x2(1/8 x 2)	JZ-12230 DT6-B927-8 4.8mm(3/16)
中厚料 Medium materials	特厚料 Extra heavy materials	厚料 Heavy material	特厚料 Extra heavy materials	薄料、中厚料 Thin materials Medium materials
1-1  S11508-101	1-2  150666-001	1-3  148864-001	1-4  150667-001	1-5  S05946-101
2-1  S40370-001	2-2  150673-001	2-3  148867-101	2-4  150675-101	2-5  S40369-001
3-1  106160-101	3-2  150668-101	3-3  148865-201	3-4  150672-101	3-5  S40355-001
4-1  183978-001	4-2  181716-001	4-3  183954-001		
5-1  148973-001	5-2  148875-001	5-3  S06310-001		
6-1  148876-001-0				

1:111443003
2:062671012
3:021670102
4:148876-001-0



JZ-12211 MS-26 B926 JZ-12212 MS-19 JZ-12225 35800



JZ-12226 927-3 1/4 JZ-12214 DT6-927



JZ-12215 DT6-B928 JZ-12216 MS-1190



JZ-12217 MS-1261 JZ-12218 DT6-B926/8A



JZ-12219 380单针 JZ-12220 380双针 JZ-12221 380



JZ-12222 380三针 JZ-12223 380三针平行 JZ-12227 1/4 RACING 瑞尔星

JINZEN® GAUGE SET



JZ-12312 L32



JZ-12313 DCZ-220



JZ-12301 M03314



JZ-12302 M02516



JZ-12314 W562-5



JZ-12315 1302



JZ-12303 SH7000



JZ-12304 AZ8020



JZ-12316 747



JZ-12317 M03614



JZ-12305 531



JZ-12306 EX3200



JZ-12318 W600



JZ-12319 JUKI 2516 SIX STREAD



JZ-12307 EF-C21



JZ-12308 W500



JZ-12320 PEGASUS SIX THREAD



JZ-12322



JZ-12309 SIRUBA SIX STREAD



JZ-12310 JUKI 3616 SIX STREAD



JZ-12321 飞马包兜机针位

GAUGE SET



JZ-12323 W500 模具针位



JZ-12324 200020B3560 GAUGE SET



JZ-12325 VT1500 导骨宽槽 4.8 针位



JZ-12326 VT1500 导骨窄槽 5.6 针位



JZ-12327 VT1500 立骨窄槽 5.6 针位



JZ-12328 VT1500 导骨 6.4 针位



JZ-12329 VT1500 导骨窄槽 4.8 针位



JZ-12330

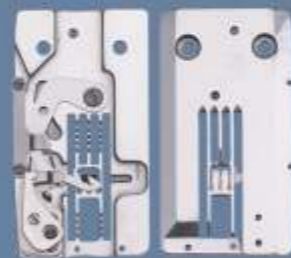

JZ-12331

JINZEN® TEFLON 铁氟龙系列



JZ-12401



JZ-12402



JZ-12403



JZ-12404



JZ-12405



JZ-12406



JZ-12413 FD



JZ-12408



JZ-12409



JZ-12410



JZ-12411



JZ-12412



JZ-12400

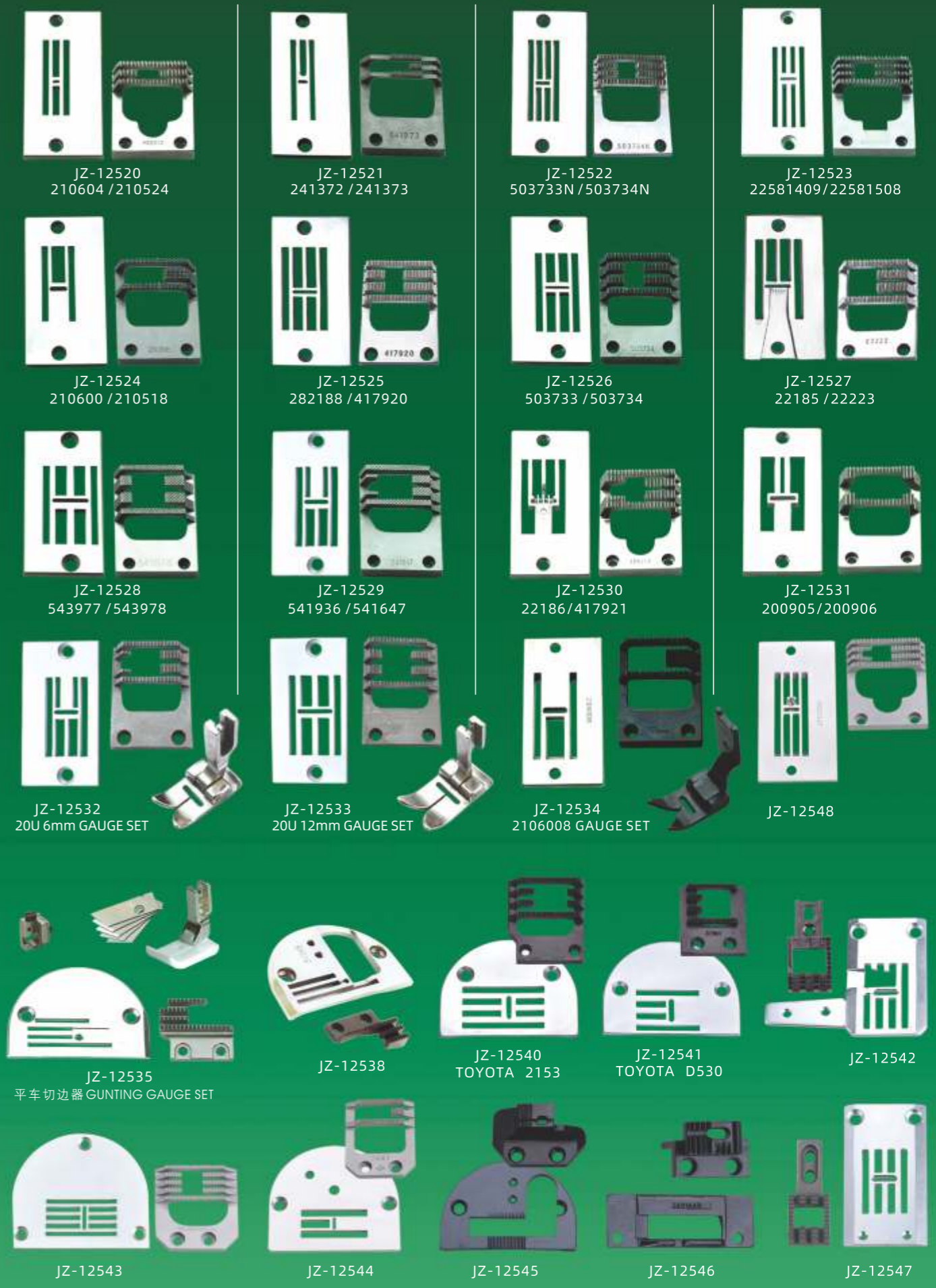

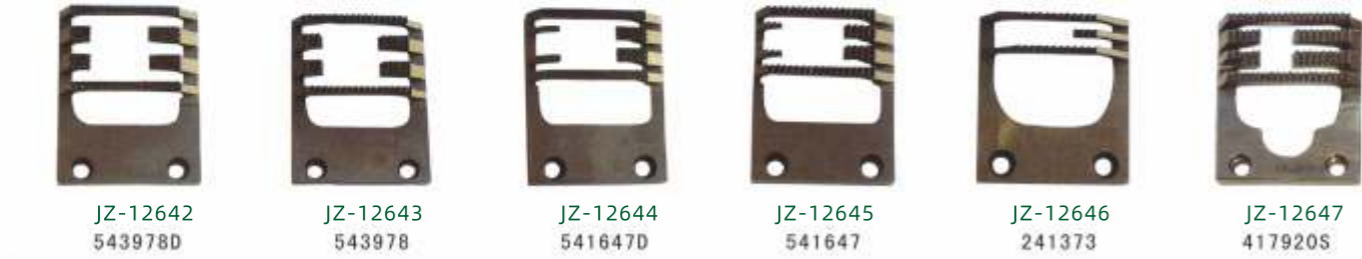
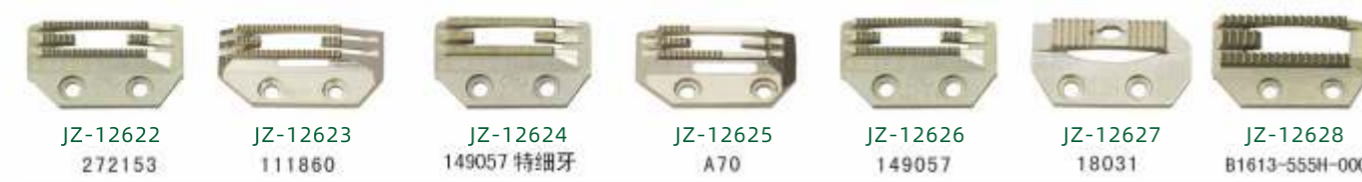

 HI258/DI206	 HI259/DI207	 257262/257216	 HI261/DI215	 257258/257206	 3209002/3209003	 DL4	 15-704	 FE15	 FD-62G 双切牙子	 FD-62G 单切牙子	 15-760
 HI262/DI216	 257259/257207	 DF00560/FDF00560	 3209001/3209000	 257290/257243	 15-8060/15-8050	 3159034/3159037	 34726F/34705F	 H1359/D1207	 3209012/3209013	 祖奇241牙	 B1657-816-000 B1656-816/B1658-804
 257242/257289	 Y3109020 Y3109021	 257243/257290	 3109000/3109001	 DFC00560/FDC00560	 H4258/D4206	 3509036/3509037	 Y3509036/Y3509037	 FE40/FE16-2/FE41	 Y93394/Y93395	 3209008/3209009	 257268-16F/257222-16F
 208217/208064	 208215/208063	 208219/208066	 146572/146567	 210445/210575	 204675A 204676	 3109002/3109003	 3509004/3509005	 15-753/15-723	 15-756/15-727	 关西四行牙	 90624/90625
 204676/208078-BF	 204676/208079-BF	 146748/146744	 H445/D574	 204732 204675 204674	 H974/D969	 Y34852/34851	 21842/21846	 6509012 6509002/6509022	 H3362/D3216	 15-36/15-301	 50326AY/50305BA
 210442/210569	 210494/210581	 210501/210582	 H501/D582	 H497/D581	 H500/D581	 146750/146745	 四线打皱牙	 202854A/201094B	 201097C/201094B	 131657-814-BOL 118-83402/87106	 131657-814-BOA 131656-814-BOA 131658-804
 H445/D575	 H494/D581	 H442/D290	 210497/210581	 204730/208090-BF	 BI657-804-00T/82107	 277327-16F 277329-16F	 Y2109050/Y2109051	 277323/277325	 H497/D498	 Y2108050/Y2108051	 Y2109000/Y2109001
 DF-8040T/82107	 BI657-814-B0E/97101	 DF-86504/FD824	 118-86504/82404	 DF-814BE/FD971	 118-86009/84004	 S20245/S20241	 S19240-001 S19212-001	 H959/D996	 H957/D002	 277304-16F 277305-16F	 277300-16F 277302-16F
 DF-85407/FD830	 I21735/83006	 118-85407/83006	 I21-73308/84004	 118-85209/82800	 I21-72805/82800	 208224/208063	 208215 / 208063	 208218/208065	 213118-16FO	 204420/208074	 118-85902 118-84103/87403

“精工细作，终成大器”

Exquisite and scrupulous working makes perfect.

JINZEN® 弯针王
LOOPER KING



三十年的技术沉淀
只为对客户的一个承诺

JUKI

118-88005-80#	118-88104-81#	118-88203-82#	118-88302-83#	119-99208-92#
121-76004-60#	121-76103-61#	124-81008-10#	124-81107-11#	B2519-804
B2521-814	B2521-804	119-99307	118-88401	119-99802
B2009-038-D00 3/16B	B2009-038-K00 3/8B	B2008-038-D00 3/16A	B2008-038-K00 3/8A	MH481 B2030-481-000
MS1190 129-69101	MS1190 129-79209	MS1190 129-79308	MS1190 129-68509	MS1190 129-68806
MS1190 129-68905	MS1190 129-68508	1/4A B2513-026-F00 MS-26	1/4B B2514-026-000 MS-26	A1/8 B2513-019-B00 MS-19
				1/8B B2514-019-B00 MS-19

HIGH QUALITY LOOPER

JINZEN®



118-90704



35825



B1239-372



B1239-373



121-77903



124-84200



118-90605



118-90001



124-84002



124-84507



120-15301



118-90506



B2311-380



B2311-382



28-3



28-3



B2312-380



B2315-380



HG-001



HG-002



HG-003



HG-004



118-90100



JZ-22304



1/4B
B2514-019-F00
MS-19



1/4C
B2515-026-F00
MS-26



1/4A
B2513-019-F00
MS-19



121-20705



118-29405



124-82600

brother



S20430001



148869
B926-6A



S08913



S20627-001



146726-001



158433



146962



S20438001



148870
B926-6A



S40391-001 3/16B
B927



S20626-001



144127



S38306



147934



S20424001



148871
B926-6A



111156-001 1/4C



S20653-001



S20418



S20415



144042



146613-001



S40375-001
B928



S40392 3/16A
B927



144049-001



146635-001



147936



148875



S40376-001
B928



111160-001 1/4B



S01249-001



B3901-880-A00



147937



S03536-001



S40377-001
B928



111162-001 1/4A



S01248-001



2200



9820

PEGASUS

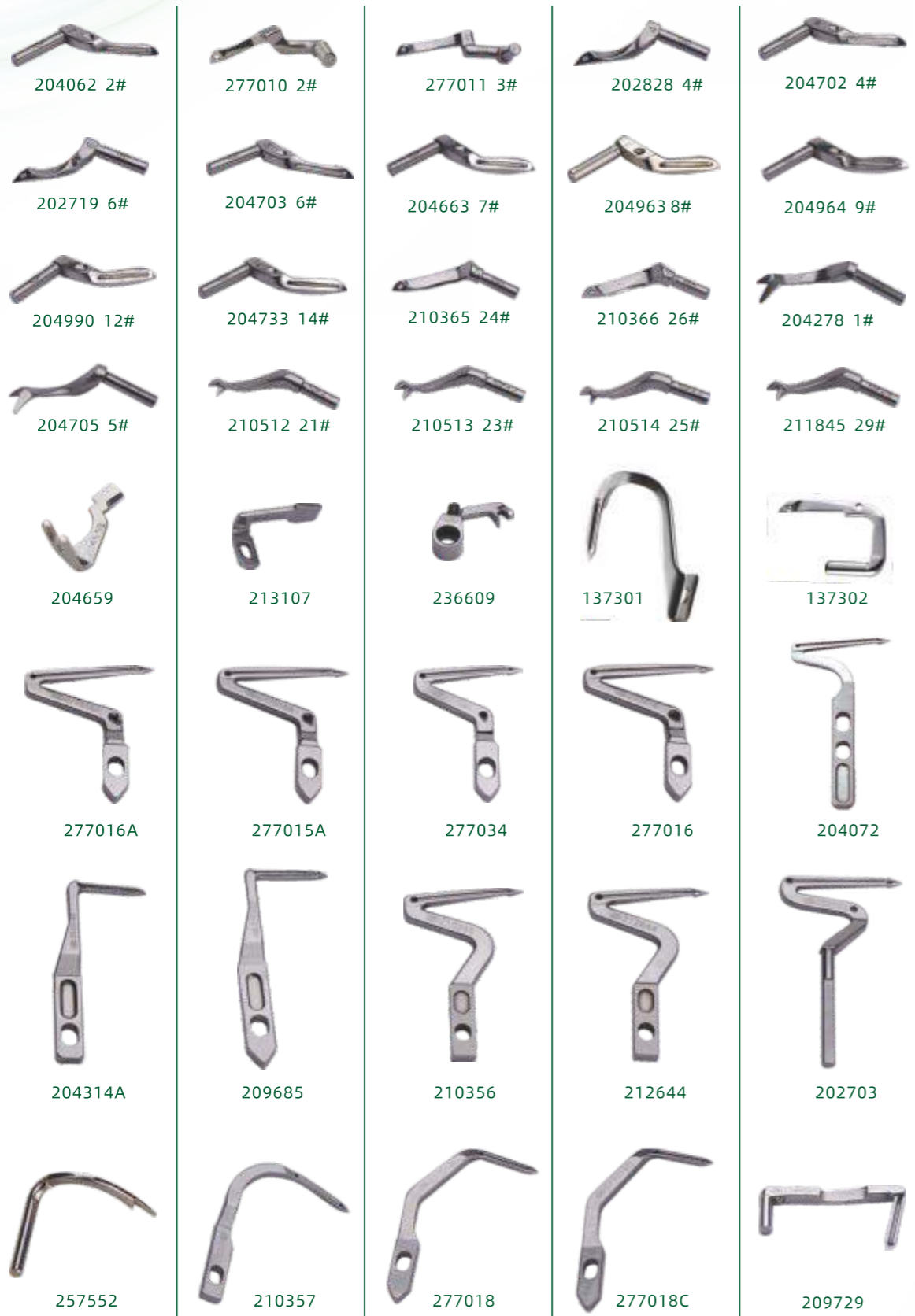

KANSAI



19-416



19-581



19-582



19-811



19-512



19-112



19-431A 2.5mm



19-431S 2.3mm



19-431 3.2mm



19-431N 2.7mm



19-525



19-531



19-353



19-362



19-518



19-535



19-801



19-363



19-351



19-539



19-713



19-810



19-536



19-712



19-807



19-505



19-751



19-437

Ijamato



6209300



6209302



6209304



2109320



2109322



32807



36228



34584



33610



3109200



2109322



68123
5.2#



68123
6.0#



6509201



2119301
Y1



2119302
Y2



3109300



2109201



2109214



2109210



6209201



6509300



68217



3209311



63178



302056



90529



94480



6509200



Y68124



6209301



32416



2109300



2109347



31261



35253



35254



34393



34392



2119324



2109212



2109302



3109310



3209300



6109305



90425



93659

HIGH QUALITY LOOPER

Kingtex



UL603883-83#



UL603882-82#



UL603880-80#



UL603881-81#



2213UL002



NG00561



NG00560



GUL604152



GUL605150



UL603886



NG603901



NG605906



5221NG0005



5212NG0004



NG604903



NG603900



5212NG0001



NG605905



LL603884



LL603885



LL2130001



5212LL0001



5212LL0002



5212NG0003



CL605294



SLF00560



SLC00560



LLC00560



51809



51808



54208B



51108DA



51909C

UNION 于仁

SINGER



32822



32820



32823



32821



32824



139056 1/4C



139433 3/16A



139433 1/4A



139057 1/4B



139288 1/4A



139434 1/4B



139434 3/16B



550411



550568



548232



548231



548205

548207

对丝机零件



JZ-P065-3



JZ-P065-4

SIRUBA



OTHER



JINZEN®

One-stop solution

缝配服务一站式采购



重机JUKI 3200 LOOPER



杜克普DURKOPP557 LOOPER



杜克普DURKOPP558 LOOPER



兄弟BROTHER980 LOOPER



利士REECE101 LOOPER



利士REECE104 LOOPER



9820



580



579



559



3200

HIGH QUALITY LOOPER

取材优质，弯针孔和弯针槽没有毛刺，角度标准个个通过严格检测。
 JINZEN looper use high-quality material, the hole and slot are grounded, and each angle standard has got through strict inspection.



Kingtex 宝狮



SEN BEN 森本



Ijamoto 大和



PEGASUS 飞马



SHING LING 星菱



brother 兄弟



JUKI 重机



SIRUBA 银箭



PRESSER FOOT



PRESSER FOOT

 PEGASUS4线 JZ-13537	 747 4线 JZ-13538	 JZ-13539	 JZ-13540	 JZ-13541	 JZ-13542	 17-301 JZ-13579	 S19260-001 JZ-13580	 201230C JZ-13581	 S19280-001 JZ-13582	 146902-001 JZ-13583	 圆线打皱压脚 JZ-13584
 JZ-13543	 JZ-13544	 JZ-13545	 JZ-13624 D/N 1/4	 257321-64 JZ-13547	 JZ-13548	 2200R 5.6MM JZ-13585	 Y95587 5.6MM JZ-13586	 257240 5.6MM JZ-13587	 VG2700 5.6MM JZ-13588	 JH004-053A 5.6MM JZ-13589	 94909 5.6MM JZ-13590
 208649 JZ-13549	 208502 JZ-13550	 P502中厚料 JZ-13551	 3316 5线 JZ-13552	 208504 JZ-13553	 P504 JZ-13554	 Y3117124 VG3711 JZ-13591	 Y3507064 VG3721 JZ-13592	 Y95316 5.6MM JZ-13593	 17-760 JZ-13594	 17-361 JZ-13595	 17-889 JZ-13596
 P233 JZ-13555	 P509 JZ-13556	 M0816 JZ-13557	 P955 JZ-13558	 208955 JZ-13559	 P005银箭包兜 JZ-13560	 211909 JZ-13597	 S19313-201 JZ-13598	 124-70258 JZ-13599	 2117035 JZ-13600	 五线打皱压脚 JZ-13601	 212887A JZ-13602
 257471-56 JZ-13561	 257472-64 JZ-13562	 W500压脚 JZ-13563	 W500滚珠压脚 JZ-13564	 257472-56 JZ-13565	 P0217 JZ-13566	 257331A56 JZ-13603	 148013-001 JZ-13604	 146871 JZ-13605	 五线窄压脚 JZ-13606	 PF634D03 JZ-13607	 圆线打皱压脚 JZ-13608
 257472-56 JZ-13565	 P0217 JZ-13566	 257471-56 JZ-13561	 257472-64 JZ-13562	 W500压脚 JZ-13563	 W500滚珠压脚 JZ-13564	 32760 JZ-13609	 32750 JZ-13610	 33539 JZ-13611	 2117024 JZ-13612	 四针六线压脚 JZ-13613	
 17-836 JZ-13567	 S08826 JZ-13568	 W500 4针六线 JZ-13569	 257461-56 JZ-13570	 257485 JZ-13571	 P5117 JZ-13626	 B1510-352-0A0 JZ-13614	 B1510-357-AA0 JZ-13615	 B1507-816-0A0 JZ-13616	 B1507-814-0A0 JZ-13617	 380 改装压脚 JZ-13627	
 YAMATO JZ-13573	 17-8850-1 JZ-13574	 208952 / 208108 JZ-13575	 119-32456 / 36804 JZ-13576	 123-30007 / 20057 JZ-13577	 YAMATO JZ-13578	 FD356 JZ-13618	 P2408 JZ-13619	 P103-4 JZ-13620	 747肩带 JZ-13621	 205136 JZ-13622	 17-899 JZ-13623

好品質，源于臺灣！
Good quality, from Taiwan!



JZ-13680
卷边压脚



JZ-13681
P351



JZ-13682
P127



JZ-13683
高低压脚

JINZEN®
PRESSER FOOT



WHOLE STEEL PRESSER FOOT 全钢压脚



JZ-13701

CL1/32N
CL1/16N
CL3/32N
CL1/8N
CL5/32N
CL3/16N
CL1/4N
CL5/16N
CL3/8N
CL1/2N



JZ-13702

CR1/32N
CR1/16N
CR3/32N
CR1/8N
CR5/32N
CR3/16N
CR1/4N
CR5/16N
CR3/8N
CR1/2N



JZ-13703

CL1/32E
CL1/16E
CL3/32E
CL1/8E
CL5/32E
CL3/16E
CL1/4E
CL5/16E
CL3/8E
CL1/2E



JZ-13704

CR1/32E
CR1/16E
CR3/32E
CR1/8E
CR5/32E
CR3/16E
CR1/4E
CR5/16E
CR3/8E
CR1/2E



JZ-13705

CLK
CL1/32K
CL1/16K
CL3/32K
CL1/8K
CL5/32K
CL3/16K
CL1/4K
CL5/16K
CL3/8K
CL1/2K



JZ-13706

CRK
CR1/32K
CR1/16K
CR3/32K
CR1/8K
CR5/32K
CR3/16K
CR1/4K
CR5/16K
CR3/8K
CR1/2K



JZ-13707

12463HR
1/32 (P810)
1/16 (P811)
3/32 (P8115)
1/8 (P812)
3/16 (P813)
1/4 (P814)
5/16 (P815)
3/8 (P816)
1/2 (P818)



JZ-13708

12463HL
1/32 (P810L)
1/16 (P811L)
3/32 (P8115L)
1/8 (P812L)
3/16 (P813L)
1/4 (P814L)
5/16 (P815L)
3/8 (P816L)
1/2 (P818L)



JZ-13709

36069HL
P69LH-1/16
P69LH-1/8
P69LH-3/16
P69LH-1/4
P69LH-5/16



JZ-13710

36069HR
P69RH-1/16
P69RH-1/8
P69RH-3/16
P69RH-1/4
P69RH-5/16



JZ-13711

SP-18L
SP-18L 1/16
SP-18L 1/8
SP-18L 3/16
SP-18L 1/4



JZ-13712

SP-18R
SP-18R 1/16
SP-18R 1/8
SP-18R 3/16
SP-18R 1/4



JZ-13713

LOT NO.
160344 1/16 (NO.1)
120938 3/32 (NO.2)
120803 1/8 (NO.2-1/2)
120804 5/32 (NO.3)
120805 3/16 (NO.4)
120940 7/32 (NO.5)
120806 1/4 (NO.6)
120803 5/16 (NO.7-1/2)



JZ-13714

A10 PRESSER FOOT
A10-5/8
A10-3/4
A10-7/8
A10-1
A10-1-1/8
A10-1-1/4
A10-1-1/2
A10-1-3/4



JZ-13715

36465
P10-1/32
P11-1/16
P115-3/32
P12-1/8
P13-3/16
P14-1/4
P15-5/16
P16-3/8
P18-1/2



JZ-13716

CD
CDN-1/32(D23N)
CD-1/32(D23)
CDN-1/16(D231N)
CD-1/16(D231)
CD-1/8(D232)
CD-3/16(D233)
CD-1/4(D234)



JZ-13717

211-15
211-13(1/16x3/16)
211-14(1/16x1/4)
211-15(1/16x5/16)
211-16(1/16x3/8)
211-18(1/16x1/2)



JZ-13718

S10R
P318R-1/8
P3316R-3/16
P314R-1/4
P3516R-5/16
P338R-3/8
P3716R-7/16
P312R-1/2
P358R-5/8
P334R-3/4
P378R-7/8
P325R-1



JZ-13719

S570R(P112H)
1/8x1/32
3/16x1/32
1/4x1/32
5/16x1/32
3/8x1/32
1/2x1/32
5/8x1/32
3/4x1/32
7/8x1/32
1" x1/32



JZ-13720

S570L (P112L)
1/8x1/32
3/16x1/32
1/4x1/32
5/16x1/32
3/8x1/32
1/2x1/32
5/8x1/32
3/4x1/32
7/8x1/32
1" x1/32



JZ-13721

S570DG (P112HD)
1/8x1/32
1/4x1/32
5/16x1/32
3/8x1/32
1/2x1/32
9/16x1/32
5/8x1/32
11/16x1/32
3/4x1/32
7/8x1/32
1" x1/32



JZ-13722

S570 (P112HL)
1/8x1/16
3/16x1/16
1/4x1/16
5/16x1/16
1/2x1/16
9/16x1/16
5/8x1/16
3/4x1/16
7/8x1/16
1" x1/16



JZ-13723

S570L (P112HL)
1/8x1/16
3/16x1/16
1/4x1/16
5/16x1/16
1/2x1/16
5/8x1/16
3/4x1/16
7/8x1/16
1" x1/16



JZ-13724

S570DG (P112HD)
3/16x1/16
1/4x1/16
5/16x1/16
3/8x1/16
1/2x1/16
9/16x1/16
5/8x1/16
11/16x1/16
3/4x1/16
7/8x1/16
1" x1/16



JZ-13725
P36LN



JZ-13726
P36N



JZ-13727
P363



JZ-13728
12435N



JZ-13729
31358N



JZ-13730
12435W



JZ-13731
121946



JZ-13732
P351



JZ-13733
24983



JZ-13734
P360



JZ-13735
P363NF



JZ-13736
P127



JZ-13737
B1524-012-0B0



JZ-13738
B1524-522-B0A



JZ-13739
B1524-522-NAA



JZ-13740
CR1/16NS



JZ-13741
P952



JZ-13742
150789



JZ-13743
S518S



JZ-13744
S518NS



JZ-13745
P31C 3/16



JZ-13746
A-10 3/4



JZ-13747
A-10 1-1/4



JZ-13748
NL-315



JZ-13749
36069L



JZ-13750
36069DG



JZ-13751
36069R



JZ-13752
P50N



JZ-13753
P5



JZ-13754
36069L 3/8



JZ-13755
P3819



JZ-13756
S540



JZ-13757
S538



JZ-13758
CF351



JZ-13759
RF1/32N



JZ-13760
LF1/4

PRESSER FOOT



JZ-14246 JZ-14247 JZ-14245 JZ-14255 JZ-14256 JZ-14257 JZ-14258 JZ-14259 JZ-14260

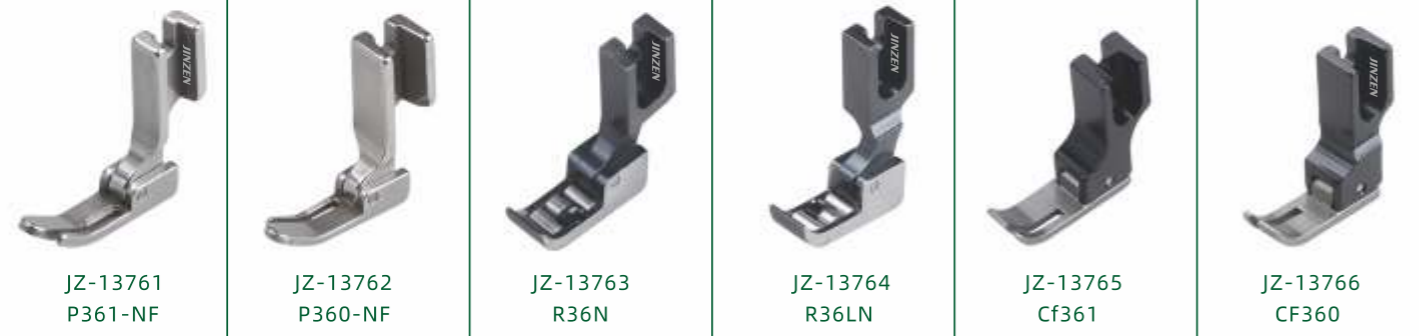

JZ-13761 P361-NF JZ-13762 P360-NF JZ-13763 R36N JZ-13764 R36LN JZ-13765 Cf361 JZ-13766 CF360

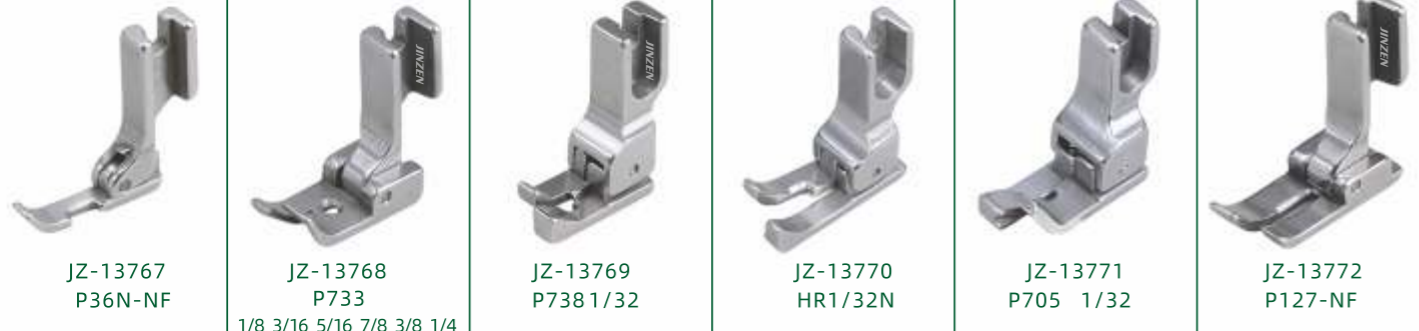

JZ-13767 P36N-NF JZ-13768 P733 1/8 3/16 5/16 7/8 3/8 1/4 JZ-13769 P738 1/32 JZ-13770 HR1/32N JZ-13771 P705 1/32 JZ-13772 P127-NF

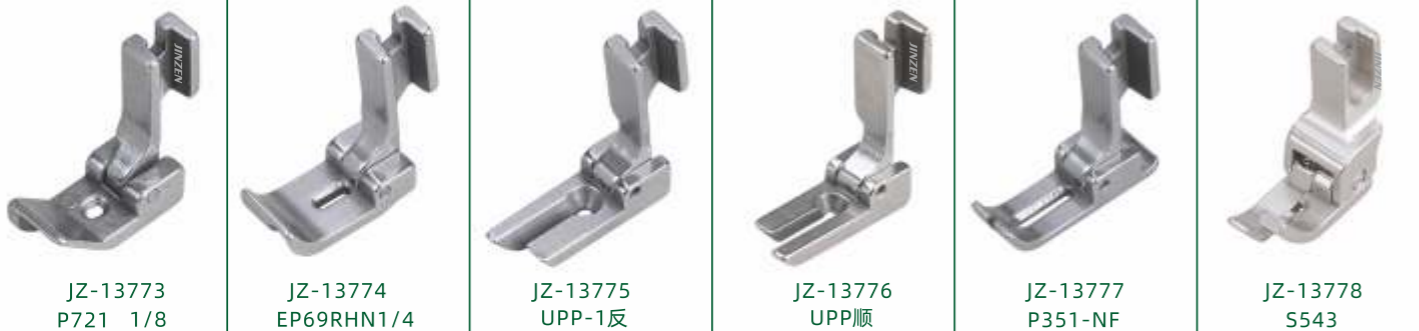

JZ-13773 P721 1/8 JZ-13774 EP69RHN1/4 JZ-13775 UPP-1反 JZ-13776 UPP顺 JZ-13777 P351-NF JZ-13778 S543



JZ-13779 P351黑 JZ-13780 P351SH JZ-13781 S955 JZ-13782 P746 3/16 1/8 JZ-13783 CR3/16-NF JZ-13784 P701 1/4 5/32



JZ-13785 KP367PL JZ-13786 KP367W JZ-13787 KH367PF JZ-13788 269RN JZ-13789 K269LN

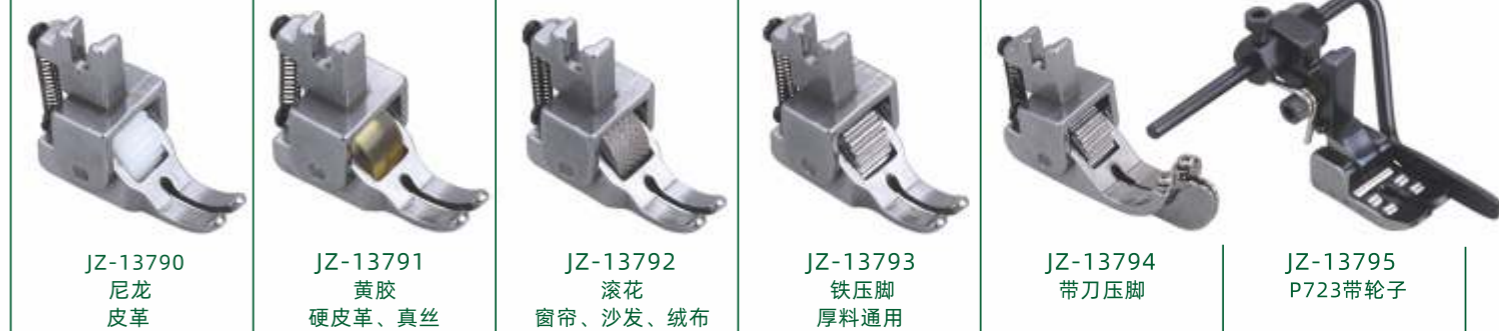

JZ-13790 尼龙皮革 JZ-13791 黄胶 硬皮革、真丝 JZ-13792 漆花 窗帘、沙发、绒布 JZ-13793 铁压脚 厚料通用 JZ-13794 带刀压脚 JZ-13795 P723带轮子

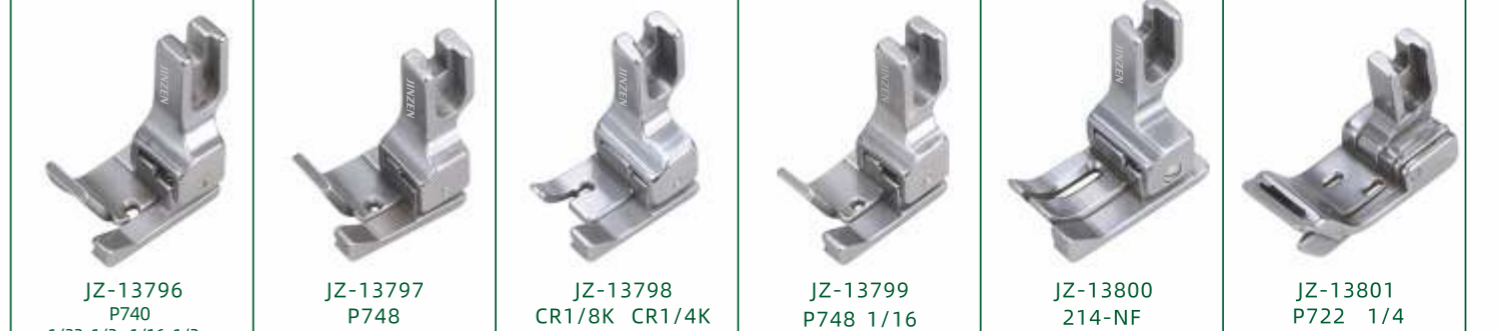

JZ-13796 P740 1/32 1/2 1/16 1/2 JZ-13797 P748 JZ-13798 CR1/8K CR1/4K JZ-13799 P748 1/16 JZ-13800 214-NF JZ-13801 P722 1/4

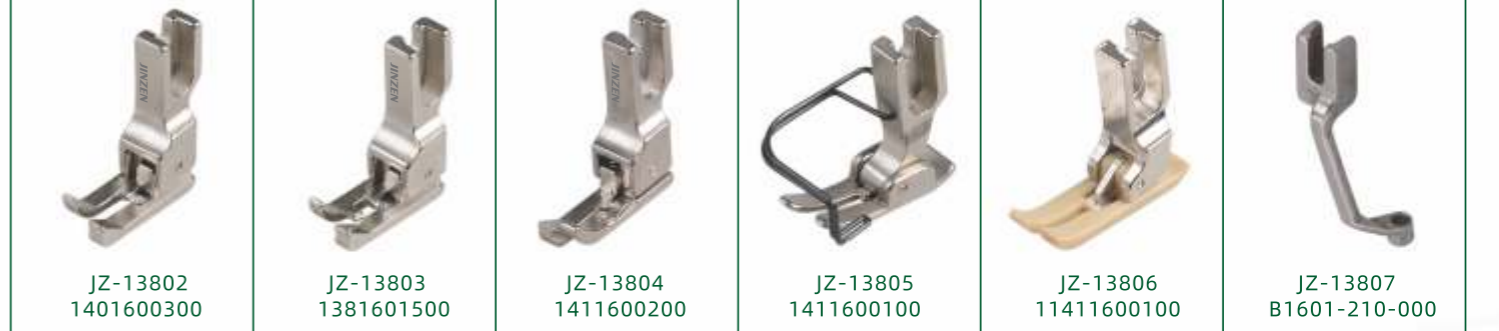

JZ-13802 1401600300 JZ-13803 1381601500 JZ-13804 1411600200 JZ-13805 1411600100 JZ-13806 11411600100 JZ-13807 B1601-210-000



JZ-13808 A B JZ-13809 A B JZ-13810 A B JZ-13811 模板机压脚方板 JZ-13812 S524 JZ-13813 花样机辅助压脚

WHOLE STEEL PRESSER FOOT 全钢压脚

											
411215 胜家人字靴-TH	10055051 祖奇人字压脚	22848671	MAB109000B0 祖奇胸罩靴	SA1231-9A 压脚	457G 13MM 胜家人字靴	21010-1L 6.4MM1/4S	21010-1R 6.4MM1/4S	21010-1L 6.4MM1/4W	21010-1R 6.4MM1/4W	212-112 1/4中带刀靴	457G-friend 梯型人字靴
											
107L 管正靴-大	23771正靴弹丝	107C 管正靴销钉-小	107C 管正靴弹-小	胜家人字靴-TH 503818	23207人字车压脚	双针打带压脚1/4	双针打带压脚 (全开槽) 1/4	23073 6.4MM 双针打带靴 (新款)	SZZM3/8 双针制帽压脚3/8	双针打拆压脚 1/4D/N	107C-4L (4L) 胜家人字靴
											
457G-KC-TS-02 人字靴开叉-弹丝-中	457G-PK-01 人字靴-平口-大	457G-PK-01 人字靴-平口-中	457G-PK-TS-01 人字靴-平口-弹丝大	457G-PK-TS-02 平口弹丝-中	457G-WC-01 人字靴-无槽-大	210569A 胜家人字靴	210569A	平车滚轮靴 F型	平车滚轮靴 (新型)	R2E滚轮压脚	1005505 JUKI 人字车压脚
											
457G-WC-02 人字靴-无槽-中	457G-WC-TS-01 人字靴-无槽-弹丝-大	457G-WC-TS-02 人字靴-无槽-弹丝-中	457 1/4 X1/32L 带刀靴	457 1/4 X1/32R 带刀靴	210569胜家人字靴	22548671 JUKI 人字车压脚	22548655 JUKI 人字车压脚	503736 人字靴 (新型)	457GB (23766A) 胸罩靴	210562A4	S950 (P950) 缩皱压脚
											
457G-KC-01 人字靴-开叉-大	457G-KC-02 人字靴-开叉-中	457 3*16X1/32R 带刀靴	457G-KC-TS-01 人字靴-开叉-弹丝-大	005-1-4A 胸罩车靴	212-005A 可调节捆条压脚	R2滚轮压脚	双针大孔压脚	P803	S537 1/4	棉花压脚	P723
											
005-1/8A胸罩车靴	457-AL 胸罩车平底靴-大	457-A 胸罩车平底靴-小	457-A 胸罩车平底靴-z弹-小	457-AL胸罩车 平底靴-弹丝-大毫	R23771滚轮压脚	652 8MM压脚	652 12MM压脚	P127L	5538105三菱双针压脚	DY340带刀压脚小号	L52-A型打折靴

PRESSER FOOT



T350 T350B
JZ-14301



T363 T363B
JZ-14302



T36LN T36LNB
JZ-14303



T36N T36NB
JZ-14304



T65212mm T652B12mm
JZ-14305



T652 9mm T652B 9mm
JZ-14306



T652 6mm T652B 6mm
JZ-14307



T36L T36LB
JZ-14308



T351 T351B
JZ-14309



T351 T351B 11mm
JZ-14310



T35WB
T35W 12.5mm
JZ-14311



Mt1 MT2
JZ-14312



MT-260B

MT-260 3/16,1/4,2/16,
3/8,1/2,3/4,1#
JZ-14313



MT-260 1/8 MT-1/8 B
JZ-14314



MT-A MT-AB 12.5mm
JZ-14315



528T-5.6 528TB
JZ-14316



T35CWB

T35CW 11MM,12.5MM,15MM
JZ-14317



T69R 1/8,1/4,3/16 T69RB
JZ-14318



T69L 1/8,1/4,3/16 T69LB
JZ-14319



T-S518 T-S518B
JZ-14320



MT-18 YELLOW
JZ-14321



T350L T350LB
JZ-14322



T-107 T-107B
12mm, 9mm, 6mm
JZ-14323



T-S518 YKK
JZ-14324



SPK6
JZ-14325



飞马五线薄料
JZ-14326



飞马五线厚料
JZ-14327



飞马四线
JZ-14328



银箭四线
JZ-14329



MF23-7 MF23-7B
JZ-14330



MF23-8 MF23-8B
JZ-14331



T350D T350DB
JZ-14332



T813 T813B
JZ-14334



T812 T812B
JZ-14335



T811 T811B
JZ-14336



T815 T815B
JZ-14337



TCL1/32,1/16,1/8,1/4,1/2
JZ-14338



TCL1/32E,1/16E,1/8E,1/4E
JZ-14339



TCR1/32, 1/16,1/8,1/4,1/2
JZ-14340



TCR1/32E,1/16E,1/8E,1/4E
JZ-14341



T814 T814B
JZ-14342



SR-DB-R SR-DB-RB
JZ-14343



TRF1-R
JZ-14344



TRF1-R (绿)
JZ-14358



0.5mm 0.8mm 1.0mm 1.2mm 1.5mm 2.0mm
JZ-14359



T8115SR T8115SRB
JZ-14346



T812SR T812SRB
JZ-14347



TRF1 TRF1B
JZ-14348



T811SR T811SRB
JZ-14349



JZ-14350



JZ-14351



JZ-14352



JZ-14353



JZ-14354



JZ-14355



JZ-14356



JZ-14357

JZ-14357





JZ-15223 Rubbe胶底
B1511-761-0A0
B1511-762-0A0
B1511-763-0A0



JZ-15224 Rubbe凸胶底
B1511-761-0A0
B1511-762-0A0
B1511-763-0A0



JZ-15225 Rsteel铁齿
B1511-761-0A0
B1511-762-0A0
B1511-763-0A0



JZ-15226 Rubbe胶底
B1511-771-0A0
B1511-772-0A0
B1511-773-0A0



JZ-15227 Rsteel凸铁齿
B1511-771-0A0
B1511-772-0A0
B1511-773-0A0



JZ-15228 Rsteel铁齿
B1511-771-0A0
B1511-772-0A0
B1511-773-0A0



JZ-15229 Rubbe胶底
150763-001 16mm
150764-001 25mm
150766-001 32mm



JZ-15230 Rubbe凸胶底
150763-001 16mm
150764-001 25mm
150766-001 32mm



JZ-15231 Rsteel铁齿
150763-001 16mm
150764-001 25mm
150766-001 32mm



JZ-15232 Rsteel铁齿
783NV 针织羊毛衫



JZ-15233 800A
S37103-101 16mm
S37102-101 25mm
S37109-102 32mm



JZ-15234 1790
400-08646 75mm
80mm
90mm
100mm
108mm
127mm
130mm
146mm



JZ-15301 Sunstar



JZ-15304 Sunstar



JZ-15305 Sunstar



JZ-15307 JUKI 8800



JZ-15308 JUKI 1900(大)



JZ-15309 Brother 7200



JZ-15310 JUKI 9000A



JZ-15311 JUKI 9000



JZ-15312 JUKI 1900(小)



JZ-15313 JUKI 522



JZ-15314 JUKI 1903



JZ-15315 SINGER 457



JZ-15316 TYPICAL 6180



JZ-15317 JUKI 400-89647



JZ-15318 (矮)



JZ-15319 JACK A5



A9 打褶器
JZ-15409



G900E 打褶器
JZ-15410



平车切刀组 SC-735
JZ-15414



SIRUBA 五线打褶器
JZ-15415



JUKI 四线打褶器
JZ-15416



JUKI 五线打褶器
JZ-15417



SIRUBA 四线打褶器
JZ-15412



PEGASUS 五线打褶器
JZ-15413



JZ-15436 36900



JZ-15437 L32



JZ-15438 兄弟



JZ-15439 M700



PEGASUS L52
JZ-15401



PEGASUS M600
JZ-15402



PEGASUS M700
JZ-15403



KINGTEX SH7000-4
JZ-15404



KINGTEX SH7000-5
JZ-15405



SIRUBA 747
JZ-15406



SIRUBA 747 卷边器
JZ-15407



SIRUBA 757
JZ-15408



JZ-15418 PGL52-A型打折压脚



JZ-15419 380 定规



JZ-15420
CW-8B GB-6 新款820定规



JZ-15421 平缝定规



JZ-15422 820D 定规



JZ-15423 AS-005993-00 定规



JZ-15424 340定规



JZ-15425 CW-8B GB-2 精工8B定规



JZ-15426 380B 定规



JZ-15435 810 定规



JZ-15411 GB-1 吊磅



MAQ-141000AO
JZ-15441

JZ-15442



W500两孔
JZ-15443



W500一孔
JZ-15444



W500老款
JZ-15445



星菱8885
JZ-15446



W600
JZ-15447



F007
JZ-15448



JINZEN®

JZ-15440
747辅助装置



JZ-15470

JINZEN®

One-stop solution

缝配服务一站式采购



JZ-15427



JZ-15428



JZ-15429



JZ-15430



JZ-15431



JZ-15432



JZ-15433



JZ-15434



JZ-15471



JZ-15472



JZ-15473



JZ-15450 917



JZ-15451 373 Thick特厚



JZ-15464 多功能



JZ-15452 373大



JZ-15453 1903



JZ-15454 430D



JZ-15455 373



JZ-15465 373加厚



JZ-15456 373 立扣



JZ-15457 373平扣



JZ-15458 917立扣



JZ-15459 917平扣



JZ-15460 1903平扣



JZ-15461 1903立扣



JZ-15462 438立扣



JZ-15463 438平扣

JINZEN®

有一种传承叫文化对传统工艺的传承延续，
是对中国数千年文明积淀的传统文化最好的回报。



JZ-15501 A10/S60 平车直角包边筒
Right Angle Bias Binder

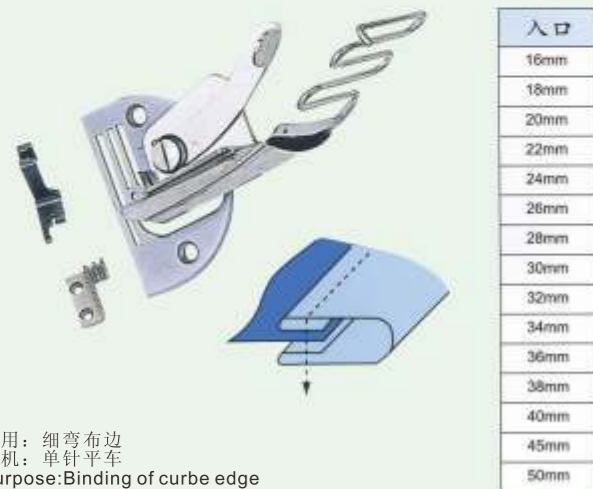

作用: 细弯布边
用机: 单针平车
Purpose: Binding of curve edge
Machine: 1 Needle Lockstitch Machine

标准厚度: M MH

JZ-15502 S64 (F531) 平车直角包边筒(散口)
Right Angle Bias Binder

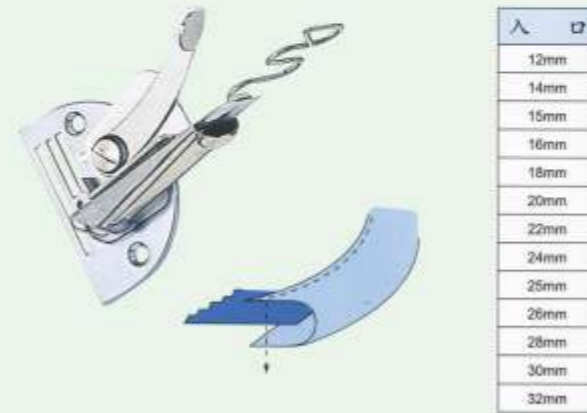

作用: 细弯布边
用机: 单针平车
Purpose: Binding of curve edge
Machine: 1 Needle Lockstitch Machine

标准厚度: M MH

JZ-15505 A30/121586(F335) 日字埋夹
Side Seam Folder-Japan Style

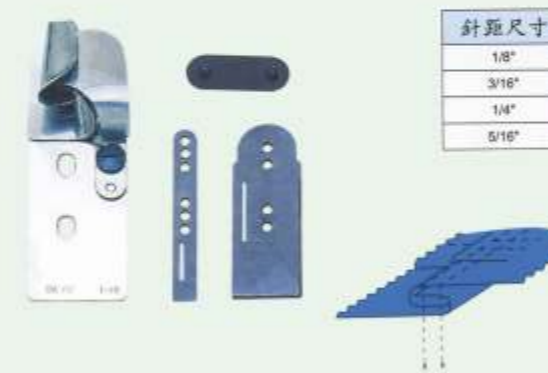

作用: 埋夹
用机: 日本制2、3针埋夹车
Purpose: Sew side seam of thick material
Machine: Japan Made 2, 3 Needle Feed of the Arm Machine

标准厚度: M MH H XH

JZ-15506 F342 切刀机耳仔筒
Belt Loop Folder for Belt Loop Machine with Cutter

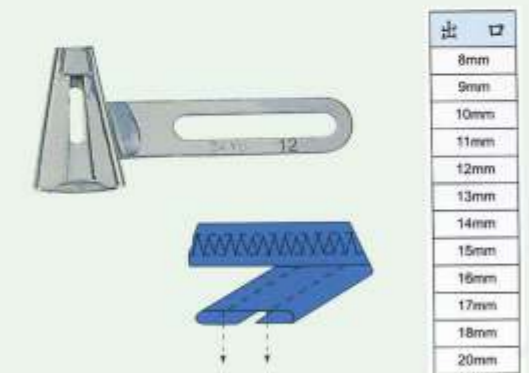

作用: 关西耳仔筒
用机: 双针耳仔车连前切刀
Purpose: Belt loop
Machine: 2 Needle Belt Loop Machine with Front Cutter

标准厚度: M MH H

JZ-15503 A11/S72L 拉脚筒
Swing Hemmer



作用: 一般直折边用
用机: 单针平车
Purpose: General straight hemming
Machine: 1 Needle Lockstitch Machine

标准厚度: M MH H

JZ-15504 A70/S70 摆动式弹弓嘴卷边器
Spring Type Swing Hemmer

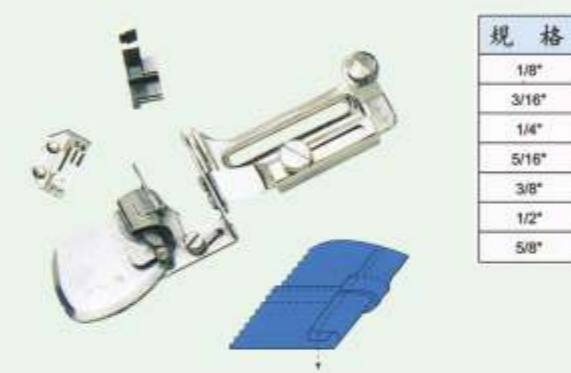

作用: 折边用, 筒嘴有弹性, 能容许厚骨通过
用机: 单针平车
Purpose: General hemming spring socket allows cross seam pass
Machine: 1 Needle Lockstitch Machine

标准厚度: M MH H

JZ-15507 F340 耳仔筒
Belt Loop Folder

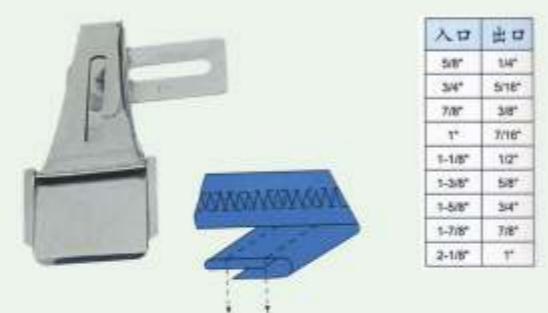

作用: 车耳仔
用机: 双针耳仔车
Purpose: Belt loop
Machine: 2 Needle Belt Loop Machine

标准厚度: M MH H

JZ-15508 F339 耳仔筒
Belt Loop Folder

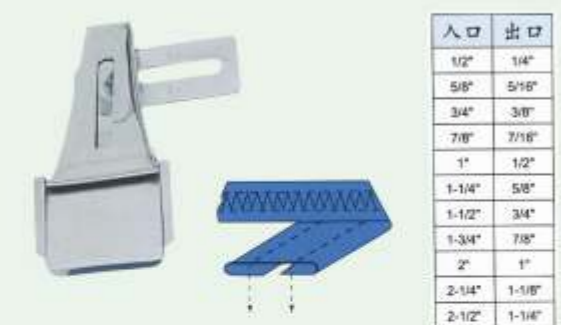

作用: 车耳仔
用机: 双针耳仔车
Purpose: Belt loop
Machine: 2 Needle Belt Loop Machine

标准厚度: M MH H

JZ-15509 AT112(F524) 双针面贴器
Double Needle Tape Attaching Foot



作用: 车双针面贴
用机: 双针车
Purpose: Attach tape on top of fabric surface
Machine: 2 Needle Machine

标准厚度:	M	MH	H
Standard Thickness:	M	MH	H

JZ-15510 K710NA(A)(F402) 绷缝车直角包边筒 (插口单折可调)
Right Angle Binder
K712NA(A) 绷缝车直角包边筒 (平口单折可调)
Right Angle Binder



作用: 拉针线T恤领、袖等
用机: 2或3针拉车
Purpose: Binding of knitwear collar and sleeve
Machine: 2 or 3 Needle Cover Stitch Machine

标准厚度:	MH	H
Standard Thickness:	MH	H

JZ-15513 A9/508 曲嘴包边筒 (环口)
Plain Bias Binder

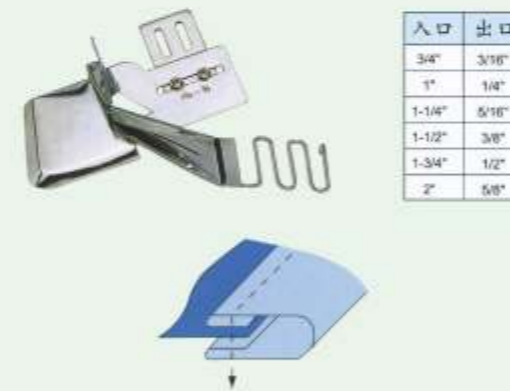

作用: 边
用机: 单针平车
Purpose: Binding edge
Machine: 1 Needle Lockstitch Machine

标准厚度:	M	MH
Standard Thickness:	M	MH

JZ-15514 曲嘴包边筒 (散口)
Braid or Tape Binder

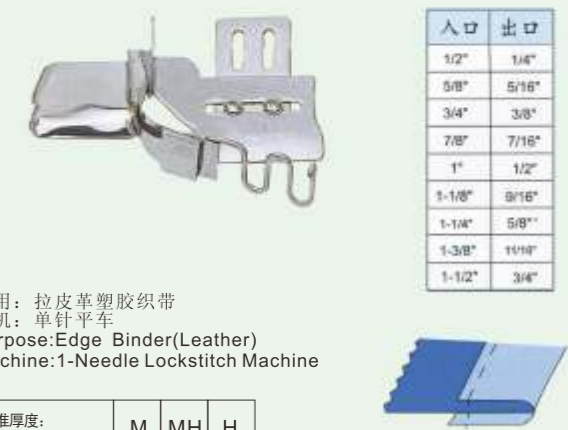

作用: 拉皮革塑胶织带
用机: 单针平车
Purpose: Edge Binder (Leather)
Machine: 1-Needle Lockstitch Machine

标准厚度:	M	MH	H
Standard Thickness:	M	MH	H

JZ-15516 祖奇包缝车包边筒 (散口)
Edge Binder for JUKI Overlock Machine



作用: 布边
用机: 祖奇包缝车

标准厚度:	M
Standard Thickness:	M

JZ-15511 K710NA(B)(F401) 绷缝车直角包边筒 (插口双折可调)
Right Angle Binder
K712NA(B) 绷缝车直角包边筒 (平口双折可调)
Right Angle Binder

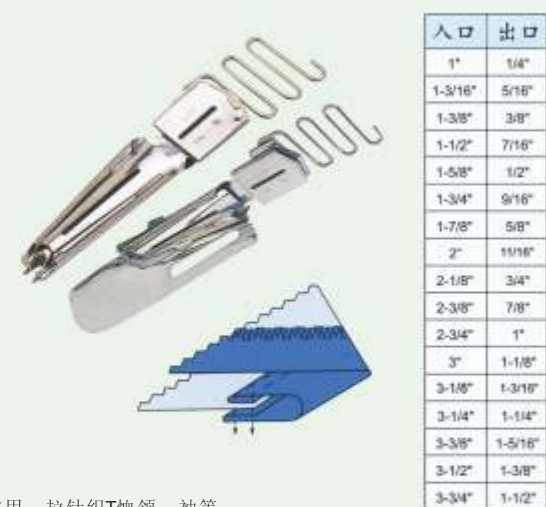

作用: 拉针线T恤领、袖等
用机: 2或3针拉车
Purpose: Binding of knitwear collar and sleeve
Machine: 2 or 3 Needle Cover Stitch Machine

标准厚度:	MH	H
Standard Thickness:	MH	H

JZ-15512 A4/100 散口曲嘴包边筒
Edge Binder

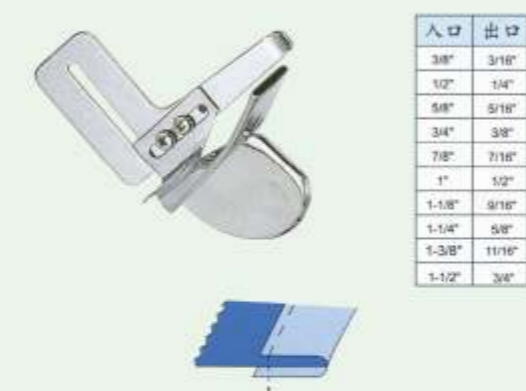

作用: 包硬身布料等
用机: 单针平车
Purpose: Binding of curve edge
Machine: 1 Needle Lockstitch Machine

标准厚度:	M	MH	H
Standard Thickness:	M	MH	H

JZ-15515 飞马包缝车包边筒
Edge Binder for Pegasus Overlock Machine

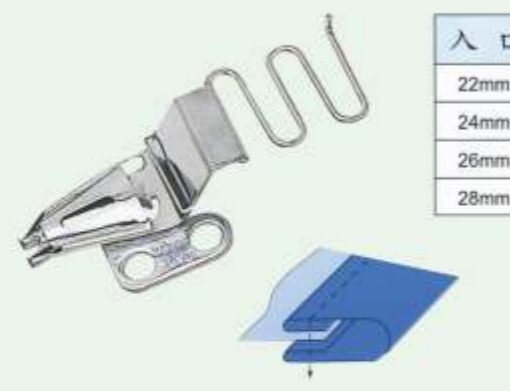

作用: 口袋边包缝
用机: 飞马L22-0E
Purpose: Pocket Binding
Machine: Pegasus L22

标准厚度:	M
Standard Thickness:	M

JZ-15516-A S174 祖奇包缝车包边筒 (散口)
Edge Binder for JUKI Overlock Machine

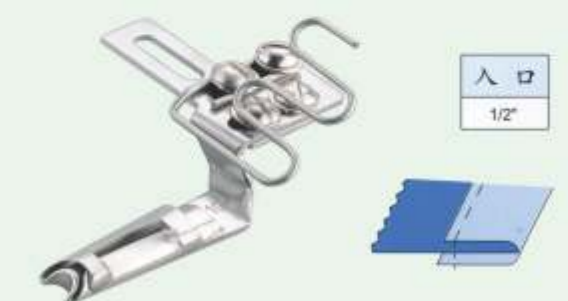

JZ-15517 祖奇包缝车包边筒
Edge Binder for Pegasus Overlock Machine

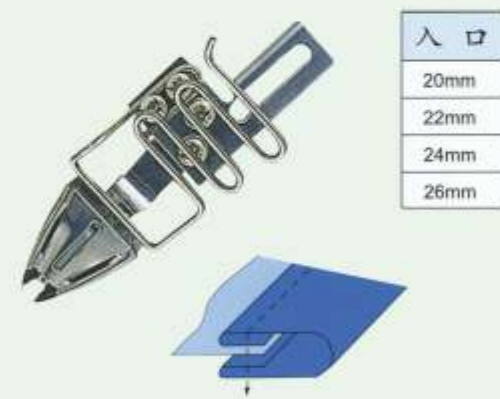

入口
20mm
22mm
24mm
26mm

作用: 布边
用机: 祖奇包缝车

标准厚度: Standard Thickness:	M
------------------------------	---

JZ-15518 散口鞋边包边筒
Single Needle Binders(for Shoes)

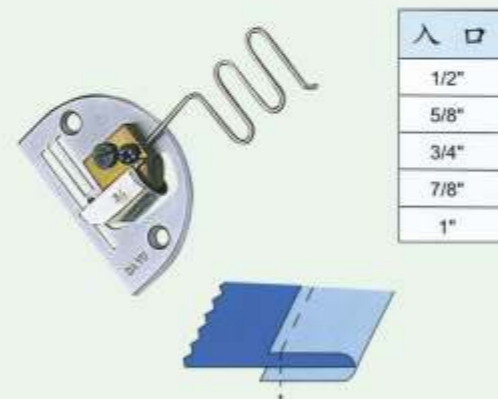

入口
1/2"
5/8"
3/4"
7/8"
1"

作用: 厚物、皮革及塑胶材料用
用机: 单针平车
Purpose: For Thick Leather and Rubber Material
Machine: 1 Needle Lockstitch Machine

标准厚度: Standard Thickness:	H	XH
------------------------------	---	----

JZ-15521 (F303) 散底裤头筒
Waist Band Folder

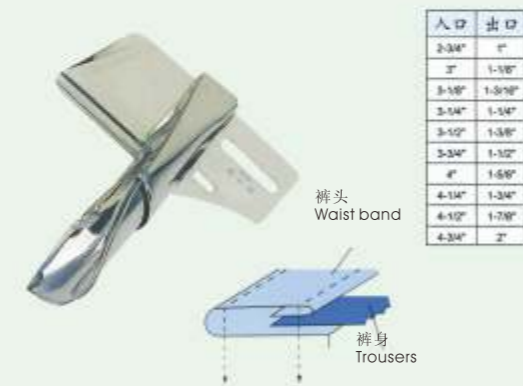

入口	出口
2-3/4"	2"
3"	1-1/8"
3-1/8"	1-3/16"
3-1/4"	1-1/4"
3-1/2"	1-3/8"
3-3/4"	1-1/2"
4"	1-5/8"
4-1/4"	1-3/4"
4-1/2"	1-7/8"
4-3/4"	2"

作用: 缝折裤头、裙头(散底、没有朴)
用机: 2或4针裤头车
Purpose: Binding of waist band(loose bottom, without lining)
Machine: 2 or 4 Needle Waist Band Machine

标准厚度: Standard Thickness:	MH	H	XH
------------------------------	----	---	----

JZ-15522 U12 雨伞筒
Twin Plain Hemmer

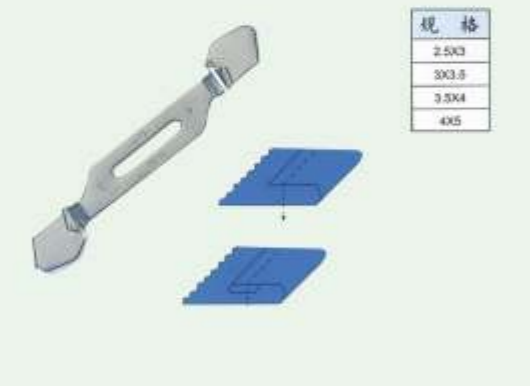

规格
2.5X3
3X3.5
3.5X4
4X5

作用: 拉伞边
用机: 单针平车
Purpose: Umbrella Edge Hemmer
Machine: 1-Needle Lock Stitch Machine

标准厚度: Standard Thickness:	M
------------------------------	---

JZ-15519 (F515) 平车靴头筒
Loop Folder Foot

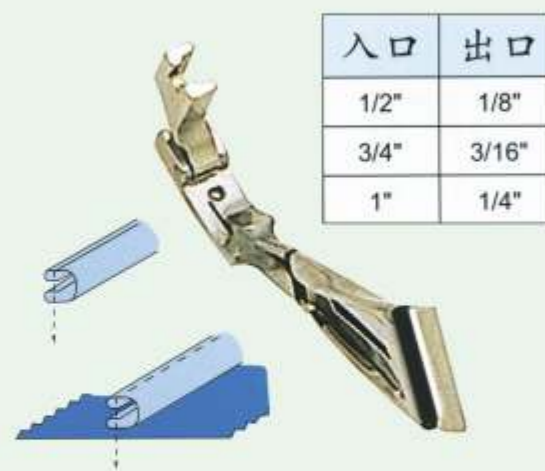

入口	出口
1/2"	1/8"
3/4"	3/16"
1"	1/4"

作用: 车耳仔
用机: 单针平车
Purpose: Loop sewing
Machine: 1 Needle Lockstitch Machine

标准厚度: Standard Thickness:	M	MH
------------------------------	---	----

JZ-15520 (F301) 裤头筒
Waist Band Folder

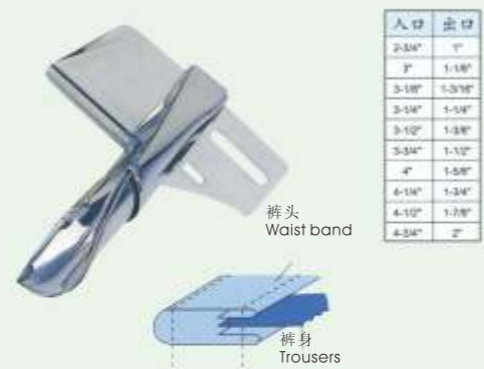

入口	出口
2-3/4"	2"
3"	1-1/8"
3-1/8"	1-3/16"
3-1/4"	1-1/4"
3-1/2"	1-3/8"
3-3/4"	1-1/2"
4"	1-5/8"
4-1/4"	1-3/4"
4-1/2"	1-7/8"
4-3/4"	2"

作用: 缝折裤头、裙头(没有朴)
用机: 2或4针裤头车
Purpose: Binding of waist band(without lining)
Machine: 2 or 4 Needle Wsist Band Machine

标准厚度: Standard Thickness:	MH	H	XH
------------------------------	----	---	----

JZ-15523 A32 双针上袖筒
Double Needle Lap Seam Folder



针距尺寸
3/16"
3/16"
3/16"
1/4"
1/4"
1/4"

作用: 缝薄布或恤衫后幅
用机: 双针车
Purpose: Back seam of shirt or light weight fabric
Machine: 2 Needle Machine

JZ-15525 35800(F337) 弹弓嘴迂仁埋夹
Sprig Type Side Seam Folder-Union Special Type

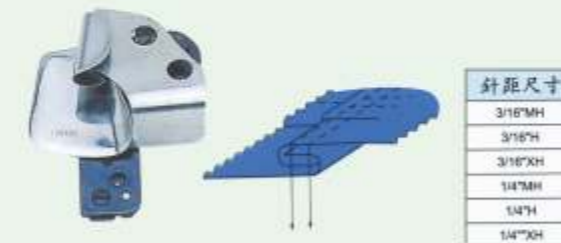

针距尺寸
3/16"
3/16"
3/16"
1/4"
1/4"
1/4"

作用: 埋夹
用机: 迂仁2、3针埋夹车
Purpose: Sew side seam
Machine: 2,3 Needle Union Special Feed of the Arm Machine

JZ-15524 F514 多条面贴器
Multi Tape Attach Folder

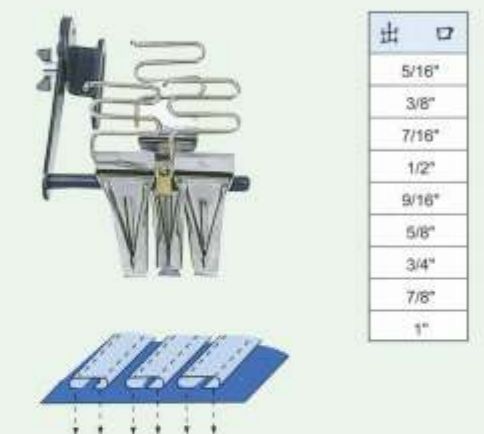

出口
5/16"
3/8"
7/16"
1/2"
9/16"
5/8"
3/4"
7/8"
1"

作用: 机恤装式面贴用
用机: 多针车
Purpose: Decorative tape on jacket
Machine: Multi Needle Machine

标准厚度: Standard Thickness:	M
------------------------------	---

JZ-15526 F404 绷缝车直角包边筒(插口子母简单折可调)
Right Angle Binder with Piping -Loose Bottom

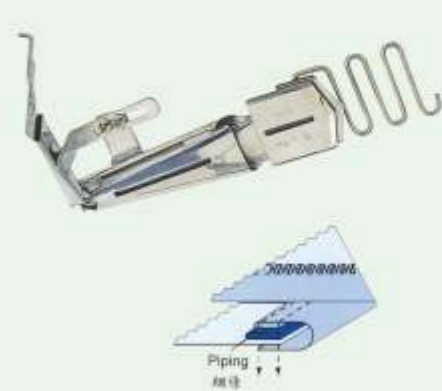

入口	出口
3/4"	1/4"
15/16"	5/16"
1-1/8"	3/8"
1-3/16"	7/16"
1-3/8"	1/2"
1-1/2"	9/16"
1-5/8"	5/8"
1-3/4"	11/16"
1-7/8"	3/4"
2-1/8"	7/8"
2-3/8"	1"

作用: 拉针织T恤领、袖、连线条
用机: 2或3针拉口车

Purpose: Binding of knitwear collar and sleeve with piping.
Machine: 2 or 3 Needle Cover Stitch Machine

标准厚度:	MH	H
Standard Thickness:	MH	H

JZ-15527 F400 绷缝车直角包边筒(插口子母简单折可调)
Right Angle Binder with Piping

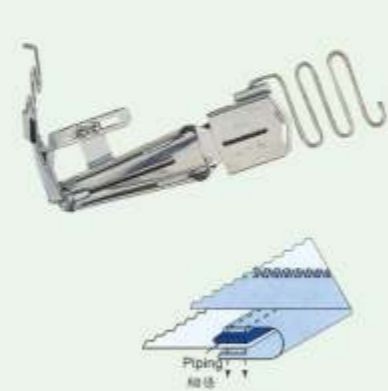

入口	出口
1"	1/4"
1-3/16"	5/16"
1-3/8"	3/8"
1-1/2"	7/16"
1-5/8"	1/2"
1-3/4"	9/16"
1-7/8"	5/8"
2"	11/16"
2-1/8"	3/4"
2-3/8"	7/8"
2-3/4"	1"

作用: 拉针织T恤领、袖、连线条
用机: 2或3针拉口车

Purpose: Binding of knitwear collar and sleeve with piping.
Machine: 2 or 3 Needle Cover Stitch Machine

标准厚度:	MH	H
Standard Thickness:	MH	H

JZ-15530 F304 散底裤头筒有补
Waist Band Folder With Lining



入口	出口
2-3/4"	1"
3"	1-1/8"
3-1/8"	1-3/16"
3-1/4"	1-1/4"
3-1/2"	1-3/8"
3-3/4"	1-1/2"
4"	1-5/8"
4-1/4"	1-3/4"
4-1/2"	1-7/8"
4-3/4"	2"

作用: 缝折裤头, 裙头(散底, 有补)
用机: 2或4针裤头车

Purpose: Binding of waist band (loose bottom, with lining.)
Machine: 2 or 4 Needle Waist Band Machine

标准厚度:	MH	H	XH
Standard Thickness:	MH	H	XH

JZ-15531 F305 封咀裤头筒
Waist Band Folder



入口	出口
3"	1-1/8"
3-1/8"	1-3/16"
3-1/2"	1-1/4"
3-3/4"	1-3/8"
4"	1-1/2"
4-1/4"	1-5/8"
4-1/2"	1-3/4"
4-3/4"	1-7/8"
5"	2"

作用: 在车缝前, 可先将裤头内折
用机: 胜嘉裤头车

Purpose: Close end of waist before stitching
Machine: Singer Waist Band Machine

标准厚度:	M	MH
Standard Thickness:	M	MH

JZ-15528 F219 侧袖筒
Sleeve Placket Binder



入口	出口
3/4"	3/16"
1"	1/4"
1-1/8"	5/16"
1-1/4"	3/8"
1-3/8"	7/16"
1-5/8"	1/2"
1-7/8"	5/8"
2-1/4"	3/4"
2-1/2"	7/8"
2-3/4"	1"

作用: 缝袖侧
用机: 单针平车

Purpose: Attach sleeve placket.
Machine: 1 Needle Lockstitch Machine

标准厚度:	M	MH	H
Standard Thickness:	M	MH	H

JZ-15529 F302 裤头筒有补
Waist Band Folder With Lining



入口	出口
2-3/4"	1"
3"	1-1/8"
3-1/8"	1-3/16"
3-1/4"	1-1/4"
3-1/2"	1-3/8"
3-3/4"	1-1/2"
4"	1-5/8"
4-1/4"	1-3/4"
4-1/2"	1-7/8"
4-3/4"	2"

作用: 缝折裤头, 裙头(有补)
用机: 2或4针裤头车

Purpose: Hemming waist band with elastic
Machine: 2,3,4 Needle Elastic Machine

标准厚度:	MH	H	XH
Standard Thickness:	MH	H	XH

JZ-15532 F306 封咀裤头筒(散底)
Waist Band Folder



入口	出口
3"	1-1/8"
3-1/8"	1-3/16"
3-1/2"	1-1/4"
3-3/4"	1-3/8"
4"	1-1/2"
4-1/4"	1-5/8"
4-1/2"	1-3/4"
4-3/4"	1-7/8"
5"	2"

作用: 在车缝前, 可先将裤头内折, (散底, 有补)
用机: 胜嘉裤头车

Purpose: Close end of waist before stitching (loose bottom, with lining)
Machine: Singer Waist Band Machine

标准厚度:	H	XH
Standard Thickness:	H	XH

JZ-15533 F218 单针接袖器(单针车用)
Single Needle Sleeve Attachment (Single Needle Operation)

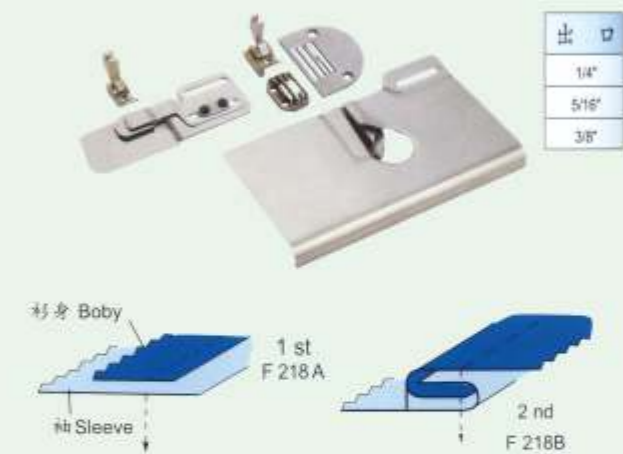

作用: 单针袖
用机: 单针平车

Purpose: Single Needle Sleeve
Machine: 1 Needle Lockstitch Machine

标准厚度:	M	MH
Standard Thickness:	M	MH

JZ-15534 432 绳子筒(固定式)
Piping Folder

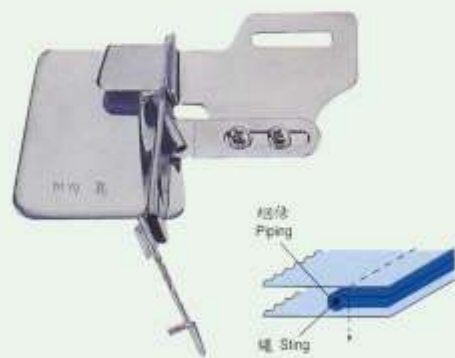

入口	出口
3/8"	3/16"
1/2"	1/4"
5/8"	5/16"
3/4"	3/8"
7/8"	7/16"
1"	1/2"
1-1/8"	9/16"
1-3/16"	19/32"
1-1/4"	5/8"
1-3/8"	11/16"
1-1/2"	3/4"
1-5/8"	13/16"
1-3/4"	7/8"

作用: 车細条连绳仔, 用于睡衣, 枕头袋等
用机: 单针平车

Purpose: Attach piping with sting e.g.pajama and pillow case
Machine: 1 Needle Lockstitch Machine

标准厚度: Standard Thickness:	M	MH	H
------------------------------	---	----	---

JZ-15535 F521 活动绳子筒
Piping Folder

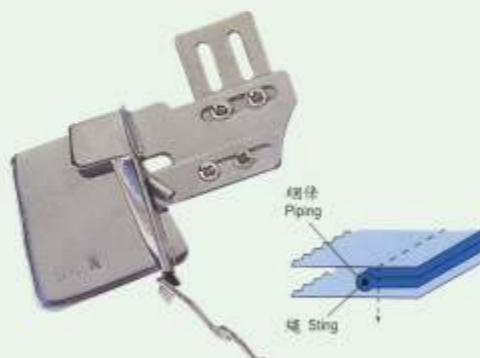

入口	出口
3/8"	3/16"
1/2"	1/4"
5/8"	5/16"
3/4"	3/8"
7/8"	7/16"
1"	1/2"
1-1/8"	9/16"
1-3/16"	19/32"
1-1/4"	5/8"
1-3/8"	11/16"
1-1/2"	3/4"
1-5/8"	13/16"
1-3/4"	7/8"

作用: 车細条连绳仔, 用于睡衣, 枕头袋等
用机: 单针平车

Purpose: Attach piping with sting e.g.pajama and pillow case
Machine: 1 Needle Lockstitch Machine

标准厚度: Standard Thickness:	M	MH	H
------------------------------	---	----	---

JZ-15538 F308 上下布弯裤头筒
Two Pieces Curve Waist Band Folder

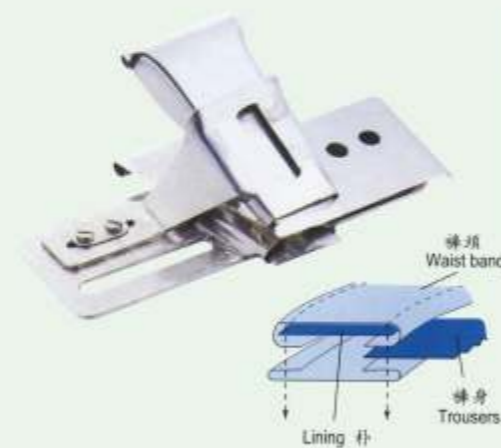

入口	出口
2-1/4"	1-1/4"
2-3/8"	1-3/8"
2-1/2"	1-1/2"
2-5/8"	1-5/8"
2-3/4"	1-3/4"

作用: 缝折弯裤头
用机: 2或4针裤头车

Purpose: Attach curve waist band.
Machine: 2 or 4 Needle Waist Band Machine

标准厚度: Standard Thickness:	H	XH
------------------------------	---	----

JZ-15539 443 绷缝车細条面贴器
Tape Attach Folder for Covering Stitch

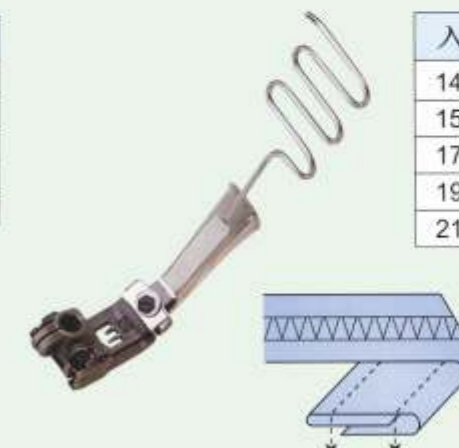

入口	出口
14mm	5.6mm
15mm	6.4mm
17mm	7.2mm
19mm	8.0mm
21mm	8.8mm

作用: 缝西裤裤头贴
用机: 裤头车

标准厚度: Standard Thickness:	MH
------------------------------	----

JZ-15536 F201 门襟筒
Top Center Plait Folder



入口	出口
1-1/2"	3/4"
1-3/4"	7/8"
2"	1"
2-1/8"	1-1/8"
2-1/4"	1-1/4"
2-3/8"	1-5/16"
2-3/8"	1-3/8"
2-1/2"	1-1/2"
2-5/8"	1-5/8"
2-3/4"	1-3/4"

作用: 男女衫前胸明筒一有朴
用机: 2或4针筒车

Purpose: Top center plait of shirt and blouse - with lining
Machine: 2 or 4 Needle Machine Placket

标准厚度: Standard Thickness:	M	MH
------------------------------	---	----

JZ-15537 F307 上下布裤头筒
Two Pieces Waist Band Folder



入口	出口
2"	1"
2-1/8"	1-1/8"
2-1/4"	1-1/4"
2-3/8"	1-3/8"
2-1/2"	1-1/2"
2-5/8"	1-5/8"
2-3/4"	1-3/4"
2-7/8"	1-7/8"
3"	2"

作用: 缝折裤头
用机: 2或4针裤头车

Purpose: Attach waist band.
Machine: 2 or 4 Needle Waist Band Machine

标准厚度: Standard Thickness:	MH	M
------------------------------	----	---

JZ-15540 F324 西裤裤头贴拉筒
Casual Trousers Waist Band Folder

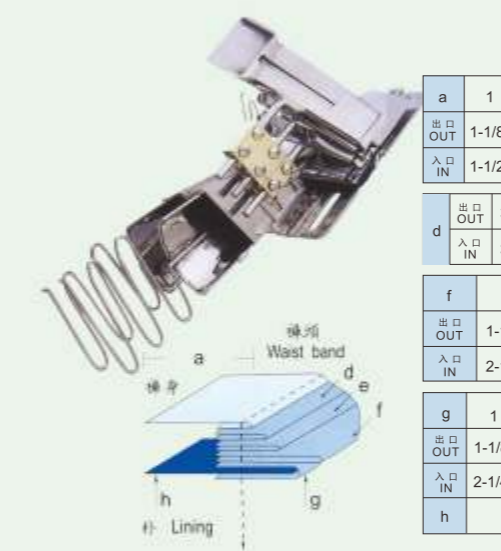

a	1	2	3	4
出口 OUT	1-1/8"	1-1/4"	1-3/8"	1-1/2"
入口 IN	1-1/2"	1-5/8"	1-3/4"	1-7/8"
d	出口 OUT 3/8"	出口 OUT 1/2"		
	入口 IN 3/4"	入口 IN 1"		
f	1	2	3	
出口 OUT	1-1/4"	1-3/8"	1-1/2"	
入口 IN	2-1/2"	2-3/4"	3"	
g	1	2	3	4
出口 OUT	1-1/8"	1-1/4"	1-3/8"	1-1/2"
入口 IN	2-1/4"	2-1/2"	2-3/4"	3"
h	1-1/4"-2"			

作用: 缝西裤裤头贴
用机: 裤头车

Purpose: Sew trousers waist band.
Machine: Waist Band Machine

标准厚度: Standard Thickness:	MH
------------------------------	----

JZ-15541 F325 西裤裤头拉筒
Casual Trousers Waist Band Folder

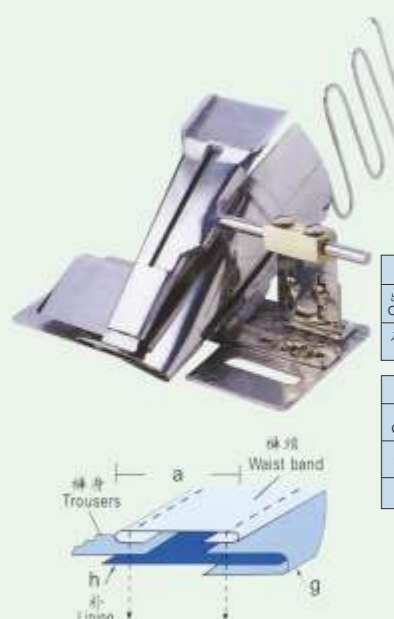

a	1	2	3	4
出口 OUT	3/4"	7/8"	1"	1-1/8"
入口 IN	1-1/2"	1-5/8"	1-3/4"	2"
g	1	2	3	4
出口 OUT	1-1/8"	1-1/4"	1-3/8"	1-1/2"
入口 IN	2-1/4"	2-1/2"	2-3/4"	3"
h	1-1/4"-2"			

作用: 缝西裤裤头
用机: 裤头车

Purpose: Sew trousers waist band.
Machine: Waist Band Machine

标准厚度: Standard Thickness:	MH
------------------------------	----

JZ-15542 KS138(A-31) 衣袖接缝器
Lap Seam Folder



作用: 薄布埋夹用
用机: 日本制2、3针埋夹车
Purpose: Sew side seam of light weight fabric
Machine: Japan Made 2、3 Needle Feed of the Arm Machine

标准厚度: Standard Thickness:	M	MH	H	XH	Needle Space 针距	3/16	1/4
------------------------------	---	----	---	----	--------------------	------	-----

JZ-15543 KS177 帽子助缝器
Hat & Cap Attachment



作用: 车帽开骨
用机: 2、4针车用
Purpose: Hat Folder
Machine: 2、4 Needle Machine

尺寸 size	入口 Bias Tape Sizes	1"	1-1/8"
------------	-----------------------	----	--------

JZ-15546 KS232 平车打条器
Pin Tuck Attachment



作用: 暗线打条
用机: 单针平车
Purpose: Loop sewing
Machine: 1 Needle Lockstitch Machine

		MF 533		Standard	
SIZE (inch)	a	1/16 - 1		Thickness:	
	c	1/8 - 11/2		T	MT

JZ-15544 F535 暗线耳仔筒
Spaghetti Attachment

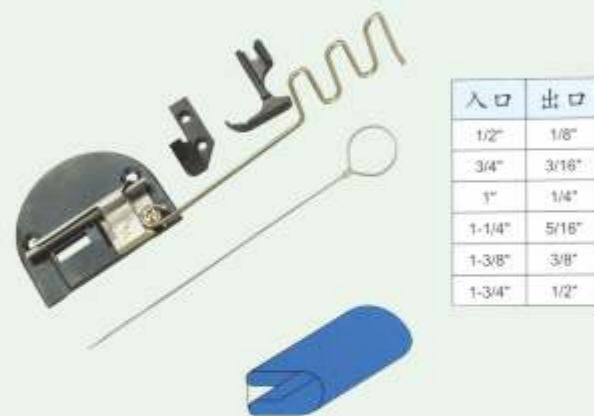

入口	出口
1/2"	1/8"
3/4"	3/16"
1"	1/4"
1-1/4"	5/16"
1-3/8"	3/8"
1-3/4"	1/2"

作用: 车暗线耳仔筒
用机: 车针平车
Purpose: Make spaghetti like tube.
Machine: 1 Needle Lockstitch Machine

标准厚度: Standard Thickness:	M
------------------------------	---

JZ-15545 F538 三尖侧贴筒
Triangular Sleeve Placket Folder



作用: 折三尖侧贴
用机: 热压辊机
Purpose: Fold triangular sleeve placket
Machine: Hot Roll Machine

标准厚度: Standard Thickness:	MH	H	XH
------------------------------	----	---	----

JZ-15547 PTV多针打褶器

6针 3/8 (9.5mm) 1/2 (12.7mm)
12针 3/16 (4.8mm) 1/4 (6.4mm)
16针 3/16 (4.8mm)
21针 1/8 (3.2mm)
25针 3/16 (4.8mm) 1/4 (6.4mm) 3/16 (4.8mm)

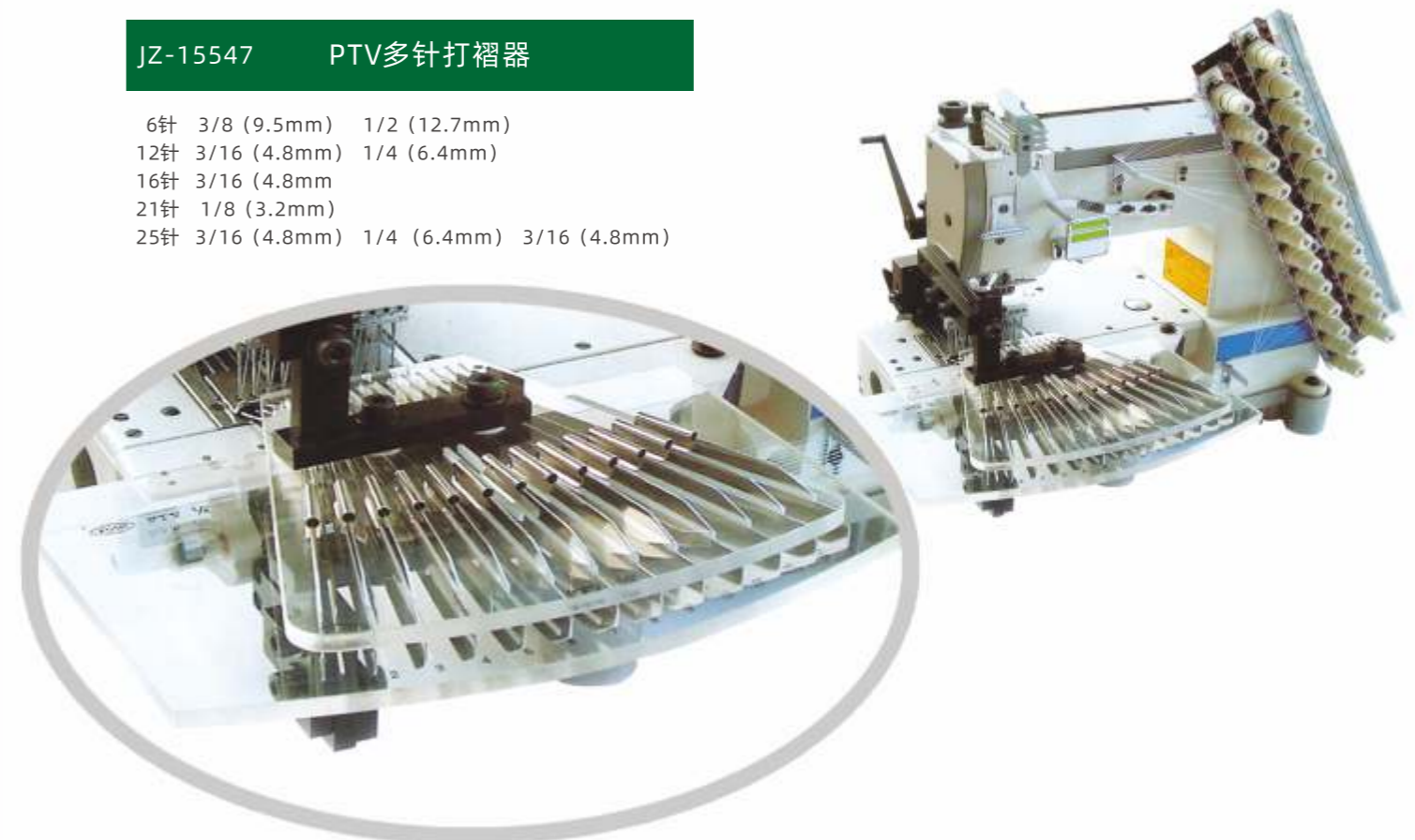

JZ-15548 E102

CUT mm	FINISH mm
100	50
110	55
120	60
130	65

RUBBER mm
30
35
40
50

E 102 A

E 102 B

JZ-15549 E126

CUT mm	FINISH mm
40	20
45	22
50	25
55	27
60	30
65	32
70	35
75	37
80	40
85	42
90	45
95	47
100	50
105	52
110	55

JZ-15552 P010

CUT mm	FINISH mm
55	20
70	25
80	30
90	35
95	40
100	42
105	45

JZ-15553 P020

CUT mm	FINISH mm
60	30
65	36
70	42
75	45
80	50

JZ-15550 C218

RUBBER mm
20
35
50
60
70
80
100

JZ-15551 P007

CUT mm	FINISH mm
55	18
60	20
70	25
85	30
95	35
100	40
110	42
120	45
125	50

JZ-15554 P024

FINISH mm
12
15

JZ-15555 P031

CUT mm	FINISH mm
24	8
28	10

JZ-15567 411棒球帽拉筒



JZ-15568 军帽拉筒



JZ-15556 P032



JZ-15557 P040



JZ-15558 P044C

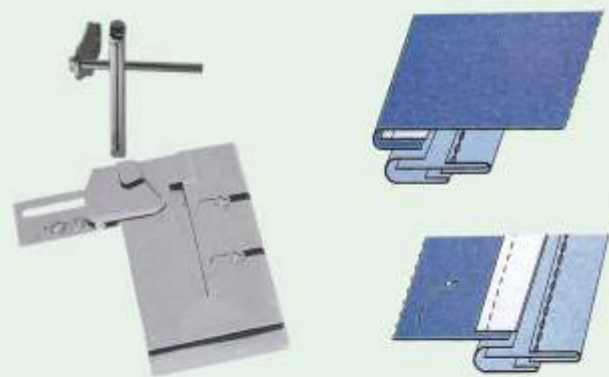

JZ-15569 P039



JZ-15570 单针袋口折边器



JZ-15571 双针袋口折边器





JZ-15651



JZ-15652



JZ-15653



JZ-15654



JZ-15655



JZ-15676



JZ-15677



JZ-15678



JZ-15679



JZ-15680



JZ-15656



JZ-15657



JZ-15658



JZ-15659



JZ-15660



JZ-15681



JZ-15682



JZ-15683



JZ-15684



JZ-15685



JZ-15661



JZ-15662



JZ-15663



JZ-15664



JZ-15665



JZ-15686



JZ-15687



JZ-15688



JZ-15689



JZ-15690



JZ-15666



JZ-15667



JZ-15668



JZ-15669



JZ-15670



JZ-15691



JZ-15692



JZ-15693



JZ-15694



JZ-15695



JZ-15671



JZ-15672



JZ-15673



JZ-15674



JZ-15675



JZ-15696



JZ-15697



JZ-15698



JZ-15699



JZ-15700



JZ-15801



JZ-15802



JZ-15803



JZ-15804



JZ-15805



JZ-15806



JZ-15807



JZ-15808



JZ-15809



JZ-15810



JZ-15811



JZ-15812



JZ-15813



JZ-15814



JZ-15815



JZ-15816



JZ-15817



JZ-15818



JZ-15819



JZ-15820



JZ-15821



JZ-15822



JZ-15823



JZ-15824



JZ-15825



JZ-15826



JZ-15827



JZ-15828



JZ-15829



JZ-15830

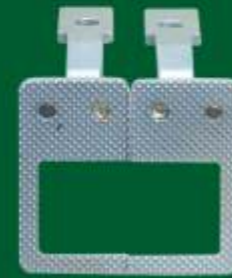

JZ-15831



JZ-15832



JZ-15833



JZ-15834



JZ-15835



JZ-15836



JZ-15837

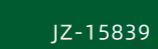

JZ-15838



JZ-15839



JZ-15840



JZ-15841



JZ-15842



JZ-15843



JZ-15844



JZ-15701

JUKI



JZ-16101



JZ-16103



JZ-16105



JZ-16107



JZ-16109



JZ-16110



JZ-16112



JZ-16114



JZ-16116



JZ-16102



JZ-16104



JZ-16106



JZ-16108



JZ-16111



JZ-16113



JZ-16115



JZ-16117



JZ-16118



JZ-16120



JZ-16122

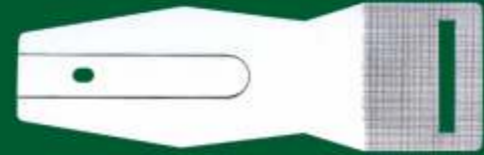

JZ-16124



JZ-16126



JZ-16128



JZ-16130



JZ-16132



JZ-16134



JZ-16119



JZ-16121



JZ-16123



JZ-16125



JZ-16127



JZ-16129



JZ-16131



JZ-16133



JZ-16135



JZ-16136



JZ-16138



JZ-16140



JZ-16142



JZ-16144



JZ-16146



JZ-16148



JZ-16150



JZ-16152



JZ-16137



JZ-16139



JZ-16141



JZ-16143



JZ-16145



JZ-16147



JZ-16149



JZ-16151



JZ-16153



JZ-16154



JZ-16156



JZ-16158



JZ-16160



JZ-16162



JZ-16164



JZ-16166



JZ-16168



JZ-16170



JZ-16155



JZ-16157



JZ-16159



JZ-16161



JZ-16163



JZ-16165



JZ-16167



JZ-16169

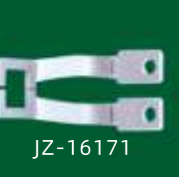

JZ-16171

brother

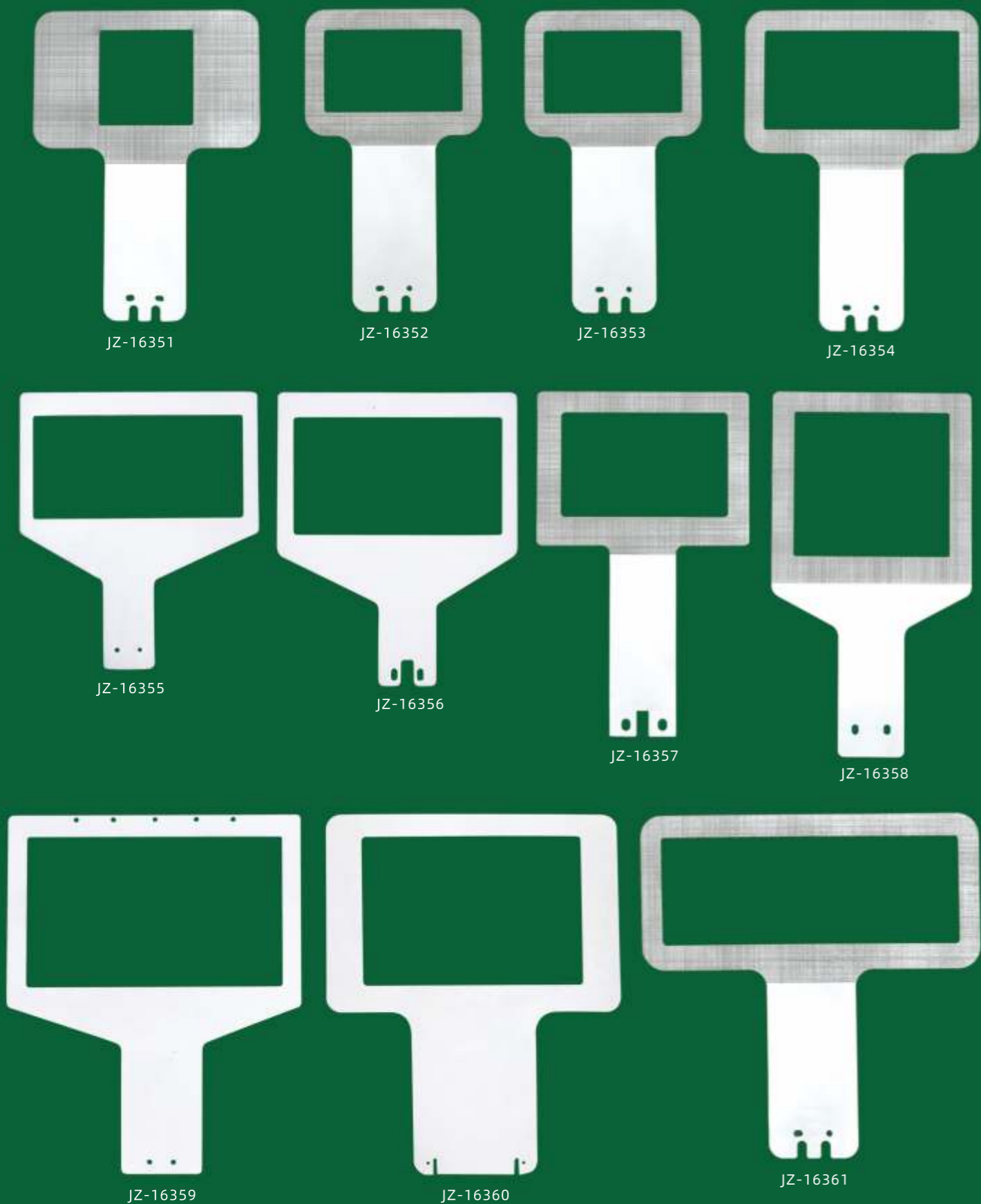



JINZEN[®]

- BROTHER 430D JZ-16615
- JUKI 373 JZ-16616
- JUKI 1190 JZ-16617
- BROTHER 927 JZ-16618
- JUKI 1261 JZ-16619
- JUKI 6700 JZ-16620
- PEGASUS M700 JZ-16621
- PEGASUS M800 JZ-16622
- JZ-16601 JUKI MH380
- JZ-16602 JUKI 5550
- JZ-16603 JUKI 1900A
- JZ-16604 JUKI 1900A黑金刚
- JZ-16605 JUKI 1790
- JZ-16606 KASAI 2000C/1702
- JZ-16607 KASAI 1404
- JZ-16608 YAMATO VC2500
- JZ-16609 KASAI WX8800
- JZ-16610 PEGASUS W500
- JZ-16611 PEGASUS W600
- JZ-16612 JUKI MF7800
- JZ-16613 SIRUBA F007
- JZ-16614 KINGTEX CT6500



JZ-16801
AZ6000



JZ-16802
MO3600



JZ-16803
988/700K



JZ-16804
MX3200



JZ-16805
EX3200黑金刚



JZ-16806
AZ6000H



JZ-16807
M700



JZ-16808
EX5100



JZ-16809
EX3200



JZ-16810
747直槽



JZ-16811
747



JZ-16812
747镀金



JZ-16813
SH7000



JZ-16814
MO6900



JZ-16815
MO6900黑金刚



JZ-16816
C31



JZ-16817
MO2500



JZ-16818
MO3300



JZ-16819
747D



JZ-16820
M600



JZ-16821
SH7000镀金



JZ-16822
747



JZ-16823
747镀金



JZ-16824
MO2500



JZ-16825
B551



JZ-16826
EX3200



JZ-16827
988/700K



JZ-16828
EX3200



JZ-16829
R53



JZ-16830
KASAI





				
JZ-17201 W600	JZ-17202 C007	JZ-17203 VC2700	JZ-17204 Mo3600	JZ-17205 B551
				
JZ-17206 Ex3200	JZ-17207 AZ60000	JZ-17208 MO2500	JZ-17209 MF7900	JZ-17210 W500
				
JZ-17211 M600	JZ-17212 747	JZ-17213 747	JZ-17214 C31	JZ-17215 VC2700
				
JZ-17216 C007	JZ-17217 VC2700	JZ-17218 MF7700	JZ-17219 SH7000	JZ-17220 MO2500
				
JZ-17221 Mo2500	JZ-17222 AZ8000	JZ-17223 AZ6000	JZ-17224 M600	JZ-17225 EX5100
				
JZ-17226 C007/F007	JZ-17227 MF7700	JZ-17228 MO6900	JZ-17229 F007	JZ-17230 EX3200
				
JZ-17231 Mf7700	JZ-17232 VC2500	JZ-17233 MO3600	JZ-17234 7700	JZ-17235 MO6900
				
JZ-17236 W500	JZ-17237 981	JZ-17238 558	JZ-17239 9820	JZ-17240 3200

JINZEN®

One-stop solution

缝配服务一站式采购

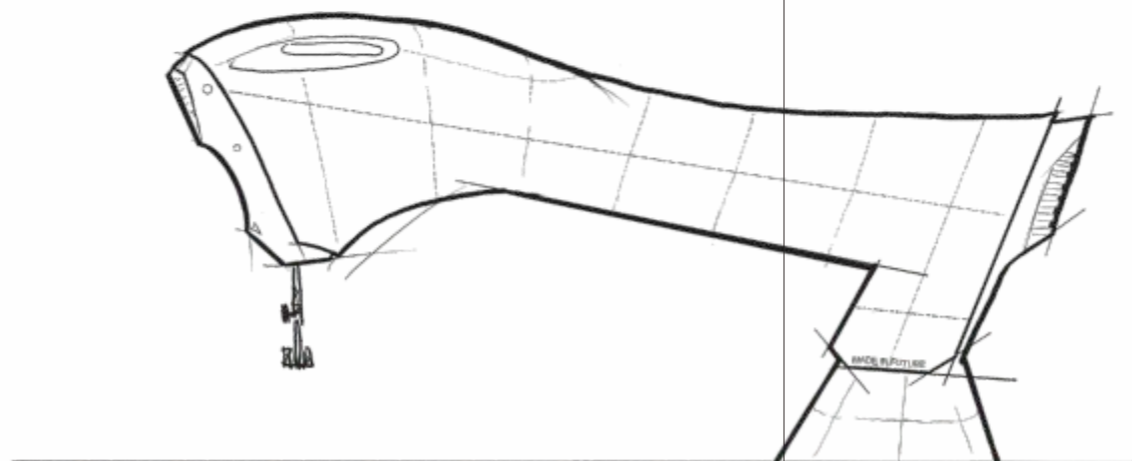
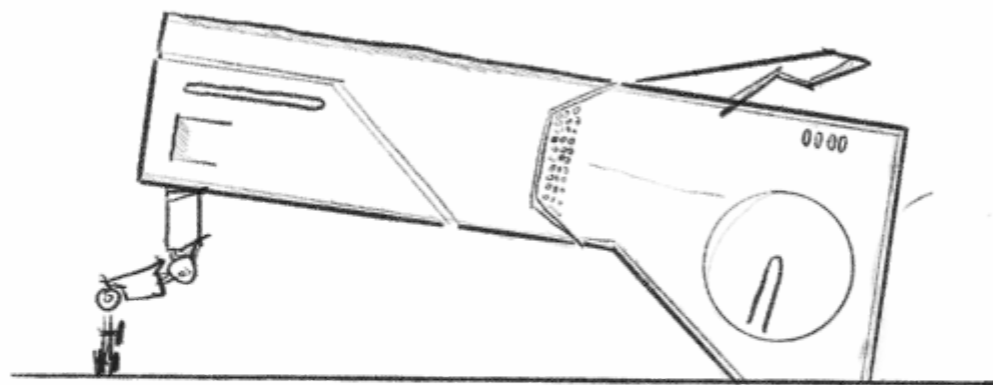
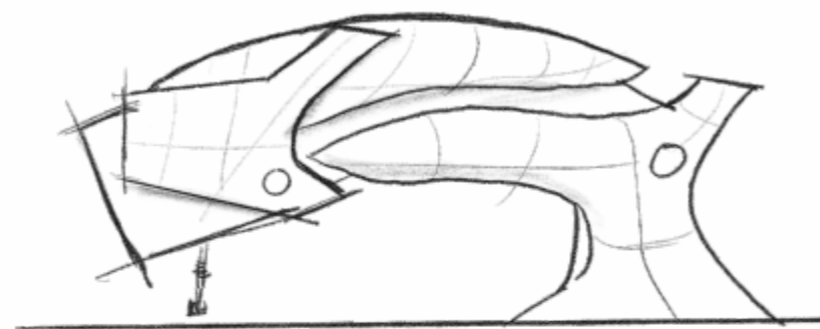

San Cer

各种整机内部配件
SEWING MACHINE SPARE PARTS

TYPICAL

ZOJE

JACK

MAGIN

PFAFF

JINZEN

SIRUBA

SINGER

Kingtex

DÜRKOPP
ADLER AG

SunStar

SHING LING

ZOX

kmsh

Eastman

KANSAI
SPECIAL

Ijamato

PEGASUS

JUKI

NEWLONG

brother

以客为尊的服务理念!

THE SERVICE IDEA OF GIVING MANY REGARDS TO CUSTOMS

JUKI
重机 1850



JZ-20051



JZ-20115

JUKI
1900/1903



JZ-20198



JZ-20199 JZ-20200



JZ-20201 JZ-20202



JZ-20203



JZ-20204 JZ-20205



JZ-20206



JZ-20207



JZ-20208



JZ-20209



JZ-20210



JZ-20211



JZ-20212



JZ-20213



JZ-20214



JZ-20215



JZ-20216



JZ-20217



JZ-20218



JZ-20219



JZ-20220



JZ-20221



JZ-20222



JZ-20223



JZ-20224



JZ-20225



JZ-20226



JZ-20227



JZ-20228



JZ-20229



JZ-20230



JZ-20231

JZ-20232



JZ-20233



JZ-20234



JZ-20235



JZ-20236



JZ-20237



JZ-20238



JZ-20239



JZ-20240



JZ-20241



JZ-20242



JZ-20243



JZ-20244



JZ-20245



JZ-20246

JZ-20247



JZ-20248

JZ-20249



JZ-20250



JZ-20255



JZ-20256



JZ-20261



JZ-20262



JZ-20268



JZ-20269



JZ-20274



JZ-20275



JZ-20280



JZ-20281



JZ-20286



JZ-20287



JZ-20291



JZ-20292



JZ-20251



JZ-20257



JZ-20263



JZ-20270



JZ-20276



JZ-20282



JZ-20288



JZ-20293



JZ-20252



JZ-20258



JZ-20264



JZ-20271



JZ-20277



JZ-20283



JZ-20289

JZ-20296



JZ-20294



JZ-20253



JZ-20259



JZ-20265



JZ-20272



JZ-20278



JZ-20284



JZ-20254



JZ-20260



JZ-20266 JZ-20267



JZ-20273



JZ-20279



JZ-20285



JZ-20290



JZ-20295



JZ-20297

JUKI
781



JUKI 781



JZ-20454



JZ-20455



JZ-20456



JZ-20457



JZ-20458



JZ-20459 JZ-20460



JZ-20461



JZ-20462



JZ-20463



JZ-20464



JZ-20465



JZ-20466



JZ-20467



JZ-20468



JZ-20469



JZ-20470



JZ-20471



JZ-20472



JZ-20473



JZ-20474



JZ-20475



JZ-20476



JZ-20477



JZ-20478



JZ-20479



JZ-20480



JZ-20481



JZ-20482



JZ-20483



JZ-20484



JZ-20485



JZ-20486



JZ-20487



JZ-20488



JZ-20489



JZ-20490



JZ-20491



JZ-20492



JZ-20493



JZ-20494



JZ-20495



JZ-20496



JZ-20498



JZ-20497

JUKI 373



JZ-20551



JZ-20552



JZ-20553



JZ-20554



JZ-20555



JZ-20556



JZ-20557



JZ-20558



JZ-20559



JZ-20560



JZ-20561 JZ-20562



JZ-20563



JZ-20564



JZ-20565



JZ-20566



JZ-20567



JZ-20568



JZ-20569



JZ-20570



JZ-20571



JZ-20572



JZ-20573



JZ-20574



JZ-20575



JZ-20576



JZ-20577



JZ-20578



JZ-20579



JZ-20580



JZ-20581



JZ-20582



JZ-20583



JZ-20584



JZ-20585



JZ-20586



JZ-20587



JZ-20588



JZ-20589



JZ-20590



JZ-20591



JZ-20592



JZ-20593



JZ-20594



JZ-20595



JZ-20596



JZ-20597



JZ-20598

JUKI 373



JZ-20599



JZ-20600



JZ-20601



JZ-20602



JZ-20603



JZ-20604



JZ-20605



JZ-20606



JZ-20607



JZ-20608



JZ-20609



JZ-20610



JZ-20611



JZ-20612



JZ-20613



JZ-20614



JZ-20615



JZ-20616



JZ-20617



JZ-20618



JZ-20619



JZ-20620



JZ-20621



JZ-20622



JZ-20623



JZ-20624



JZ-20625



JZ-20626



JZ-20627



JZ-20628



JZ-20694



JZ-20630



JZ-20631



JZ-20632



JZ-20633



JZ-20634



JZ-20635



JZ-20636



JZ-20637



JZ-20638



JZ-20639



JZ-20640



JZ-20641



JZ-20642



JZ-20643



JZ-20644



JZ-20645



JZ-20646



JZ-20647



JZ-20648



JZ-20649



JZ-20650



JZ-20651



JZ-20652



JZ-20653



JZ-20654



JZ-20655



JZ-20656



JZ-20657



JZ-20658



JZ-20659



JZ-20660



JZ-20661



JZ-20662



JZ-20663



JZ-20664



JZ-20665



JZ-20666



JZ-20667



JZ-20668



JZ-20669



JZ-20670



JZ-20671



JZ-20672



JZ-20673



JZ-20674



JZ-20675 JZ-20676



JZ-20677



JZ-20678



JZ-20679



JZ-20680



JZ-20681



JZ-20682



JZ-20683



JZ-20684



JZ-20685



JZ-20686



JZ-20687



JZ-20688



JZ-20689



JZ-20690

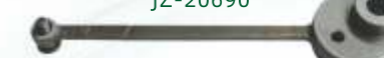

JZ-20691

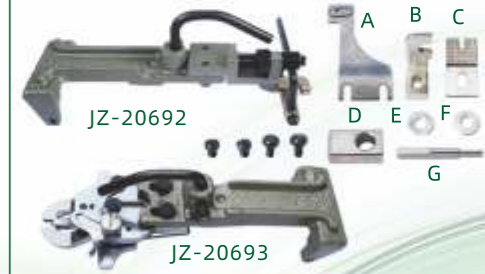

JZ-20692



JZ-20693



A B C
D E F G

**JUKI
ddl9000**



细心、精心、用心，品质永保称心。

Carefully, carefully, carefully, the quality Yongbao Heart.

JUKI
380



JZ-20901



JZ-20902



JZ-20903



JZ-20904



JZ-20905



JZ-20942



JZ-20943



JZ-20944



JZ-20945



JZ-20946



JZ-20947



JZ-20906



JZ-20907



JZ-20908



JZ-20909



JZ-20910



JZ-20911



JZ-20948



JZ-20949



JZ-20950



JZ-20951



JZ-20952



JZ-20953



JZ-20912



JZ-20913



JZ-20914



JZ-20915



JZ-20916



JZ-20917



JZ-20954



JZ-20955



JZ-20956



JZ-20957



JZ-20958



JZ-20959



JZ-20918



JZ-20919



JZ-20920



JZ-20921



JZ-20922



JZ-20923



JZ-20960



JZ-20961



JZ-20962



JZ-20963



JZ-20964



JZ-20965



JZ-20924



JZ-20925



JZ-20926



JZ-20927



JZ-20928



JZ-20929



JZ-20966



JZ-20967



JZ-20968



JZ-20969



JZ-20970



JZ-20971



JZ-20930



JZ-20931



JZ-20932



JZ-20933



JZ-20934



JZ-20935



JZ-20972



JZ-20973



JZ-20974



JZ-20975



JZ-20976



JZ-20977



JZ-20978



JZ-20979



JZ-20936



JZ-20937



JZ-20938



JZ-20939



JZ-20940



JZ-20941



JZ-20980



JZ-20981



JZ-20982



JZ-20983

JUKI
1190 埋夹配件



JZ-21021 JZ-21022



JZ-21023 JZ-21024 JZ-21025



JZ-21026



JZ-21027 JZ-21028



JZ-21029 JZ-21030 JZ-21031



JZ-21032



JZ-21033 JZ-21034



JZ-21035 JZ-21036 JZ-21037



JZ-21038



JZ-21039 JZ-21040



JZ-21041 JZ-21042 JZ-21043



JZ-21044



JZ-21045 JZ-21046



JZ-21047 JZ-21048 JZ-21049



JZ-21050



JZ-21051 JZ-21052



JZ-21053 JZ-21054 JZ-21055

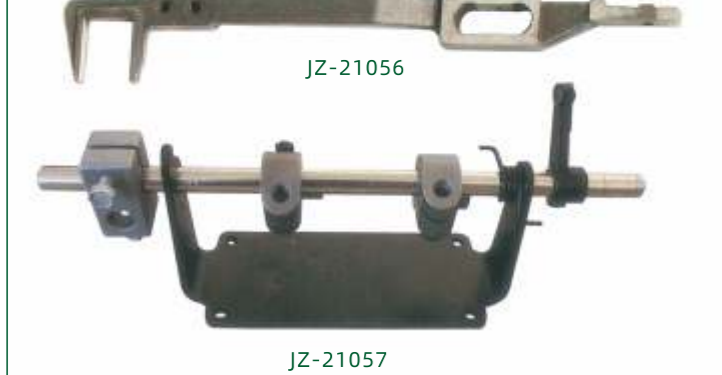

JZ-21056

JZ-21057

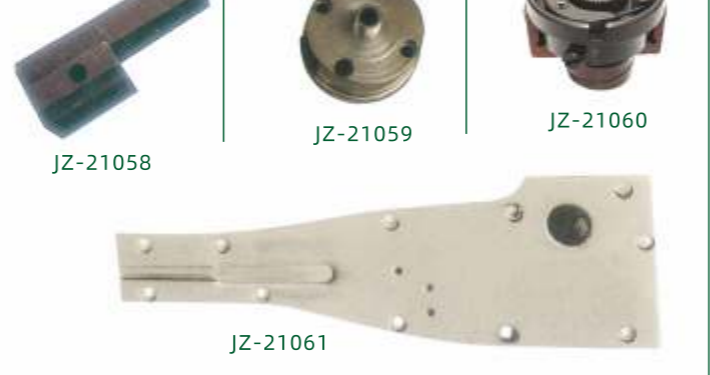

JZ-21058

JZ-21059

JZ-21060

JZ-21061



JZ-21062



JZ-21063 JZ-21064



JZ-21065 JZ-21066



JZ-21067



JZ-21068



JZ-21069 JZ-21070



JZ-21071 JZ-21072



JZ-21073



JZ-21074



JZ-21075 JZ-21076



JZ-21077 JZ-21078



JZ-21079



JZ-21080



JZ-21081 JZ-21082



JZ-21083 JZ-21084



JZ-21085



JZ-21086



JZ-21087 JZ-21088



JZ-21089 JZ-21090



JZ-21091



JZ-21092 JZ-21093

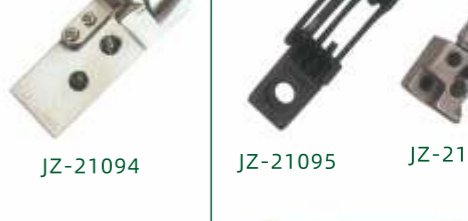

JZ-21094 JZ-21095



JZ-21096 JZ-21097



JZ-21098



JZ-21099 JZ-21100



JZ-21101 JZ-21102



JZ-21103



JZ-21104



JZ-21105 JZ-21106



JZ-21107 JZ-21108



JZ-21109

JUKI
2280









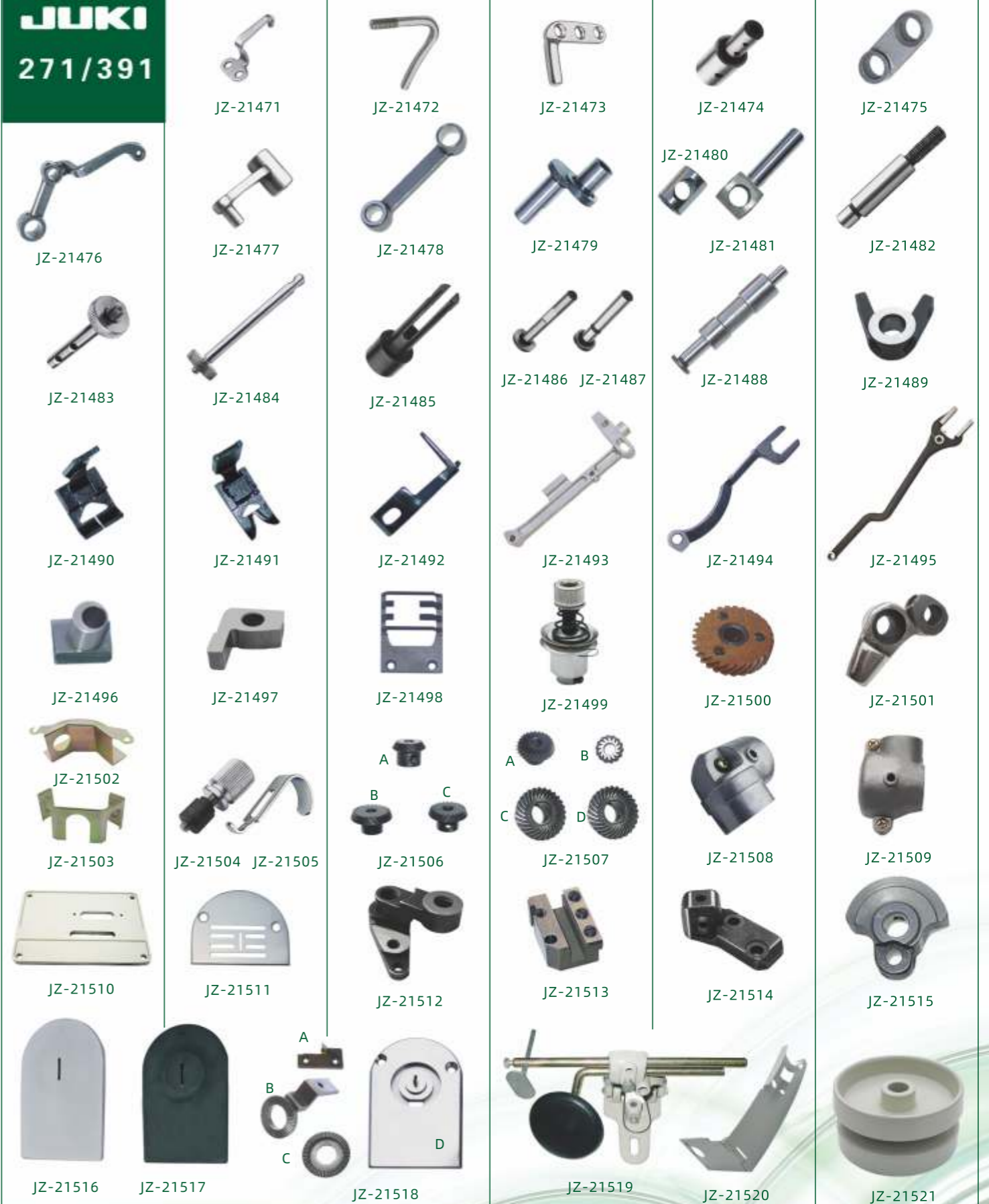



































































































JUKI
2280



JUKI
271/391



JUKI MO2516

											
JZ-21576	JZ-21577	JZ-21578	JZ-21579	JZ-21580	JZ-21581	JZ-21632	JZ-21633	JZ-21634	JZ-21635	JZ-21636	JZ-21637
											
JZ-21582	JZ-21583	JZ-21584	JZ-21585	JZ-21586	JZ-21587	JZ-21638	JZ-21639	JZ-21640	JZ-21641	JZ-21642	JZ-21643
											
JZ-21588	JZ-21589	JZ-21590	JZ-21591	JZ-21592	JZ-21593	JZ-21644	JZ-21645	JZ-21646	JZ-21647	JZ-21648	JZ-21674
											
JZ-21594	JZ-21595	JZ-21596	JZ-21597	JZ-21598	JZ-21599	JZ-21600	JZ-21601	JZ-21602	JZ-21603	JZ-21604	JZ-21605
											
JZ-21602	JZ-21603	JZ-21604	JZ-21605	JZ-21606	JZ-21607	JZ-21612	JZ-21613	JZ-21614	JZ-21615	JZ-21616	JZ-21617
											
JZ-21608	JZ-21609	JZ-21610	JZ-21611	JZ-21612	JZ-21613	JZ-21618	JZ-21619	JZ-21620	JZ-21621	JZ-21622	JZ-21623
											
JZ-21614	JZ-21615	JZ-21616	JZ-21617	JZ-21618	JZ-21619	JZ-21624	JZ-21625	JZ-21626	JZ-21627	JZ-21628	JZ-21629
											
JZ-21620	JZ-21621	JZ-21622	JZ-21623	JZ-21624	JZ-21625	JZ-21662	JZ-21663	JZ-21664	JZ-21665	JZ-21666	JZ-21667
											
JZ-21662	JZ-21663	JZ-21664	JZ-21665	JZ-21666	JZ-21667	JZ-21670	JZ-21671	JZ-21672	JZ-21673		

JUKI
MO3600

										
JZ-21721	JZ-21722	JZ-21723	JZ-21724	JZ-21725	JZ-21768	JZ-21769	JZ-21770	JZ-21771	JZ-21772	JZ-21773
										
JZ-21726	JZ-21727	JZ-21728	JZ-21729	JZ-21730	JZ-21731	JZ-21774	JZ-21775	JZ-21776	JZ-21777	JZ-21778
										
JZ-21732	JZ-21733	JZ-21734	JZ-21735	JZ-21736	JZ-21737	JZ-21780	JZ-21781	JZ-21782	JZ-21783	JZ-21784
										
JZ-21738	JZ-21739	JZ-21740	JZ-21741	JZ-21742	JZ-21743	JZ-21786	JZ-21787	JZ-21788	JZ-21789	JZ-21790
										
JZ-21744	JZ-21745	JZ-21746	JZ-21747	JZ-21748	JZ-21749 JZ-21815	JZ-21792	JZ-21793	JZ-21794	JZ-21795	JZ-21796
										
JZ-21750	JZ-21751	JZ-21752	JZ-21753	JZ-21754	JZ-21755	JZ-21798	JZ-21816	JZ-21799	JZ-21800	JZ-21801
										
JZ-21756	JZ-21757	JZ-21758	JZ-21759	JZ-21760	JZ-21761	JZ-21803	JZ-21804	JZ-21805	JZ-21806	JZ-21807
										
JZ-21762	JZ-21763	JZ-21764	JZ-21765	JZ-21766	JZ-21767	JZ-21809	JZ-21810	JZ-21811	JZ-21812	JZ-21813
										
						JZ-21814				

JUKI
MO3300

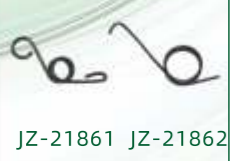

JZ-21861 JZ-21862



JZ-21863



JZ-21864 JZ-21865



JZ-21866



JZ-21867



JZ-21910



JZ-21911



JZ-21912



JZ-21913



JZ-21914 JZ-21915



JZ-21916



JZ-21868



JZ-21869



JZ-21870



JZ-21871



JZ-21872



JZ-21873



JZ-21917



JZ-21918



JZ-21919



JZ-21920



JZ-21921



JZ-21922



JZ-21874



JZ-21875



JZ-21876



JZ-21877



JZ-21878



JZ-21879



JZ-21923



JZ-21924



JZ-21925



JZ-21926



JZ-21927



JZ-21928



JZ-21880



JZ-21881



JZ-21882



JZ-21883



JZ-21884



JZ-21885



JZ-21929



JZ-21930



JZ-21931



JZ-21932



JZ-21933



JZ-21934



JZ-21886



JZ-21887



JZ-21888



JZ-21889



JZ-21890



JZ-21891



JZ-21935



JZ-21936



JZ-21937



JZ-21938



JZ-21939



JZ-21940



JZ-21892



JZ-21893



JZ-21894



JZ-21895



JZ-21896



JZ-21897



JZ-21941



JZ-21942



JZ-21943



JZ-21944
JZ-21945



JZ-21946



JZ-21947



JZ-21898



JZ-21899



JZ-21900



JZ-21901



JZ-21902



JZ-21903



JZ-21948



JZ-21949



JZ-21950



JZ-21951
JZ-21952



JZ-21953
JZ-21954
JZ-21955



JZ-21904



JZ-21905



JZ-21906



JZ-21907



JZ-21908



JZ-21909



JZ-21957



JZ-21958



JZ-21959



JZ-21956

JUKI
7700/7800

				
JZ-23501	JZ-23502	JZ-23503	JZ-23504	JZ-23505
				
JZ-23506	JZ-23507	JZ-23508	JZ-23509	JZ-23510
				
JZ-23512	JZ-23513	JZ-23514	JZ-23515	JZ-23516
				
JZ-23518	JZ-23519	JZ-23520	JZ-23521	JZ-23522
				
JZ-23524	JZ-23525	JZ-23526	JZ-23527	JZ-23528
				
JZ-23530	JZ-23531	JZ-23532	JZ-23533	JZ-23534
				
JZ-23536	JZ-23537	JZ-23538	JZ-23539	JZ-23540
				
JZ-23541	JZ-23542	JZ-23543	JZ-23544	

					
JZ-23545	JZ-23546	JZ-23547	JZ-23548	JZ-23549	JZ-23550
					
JZ-23551	JZ-23552	JZ-23553	JZ-23554	JZ-23555	JZ-23556
					
JZ-23557	JZ-23558	JZ-23559	JZ-23560	JZ-23561	JZ-23562
					
JZ-23563	JZ-23564	JZ-23565	JZ-23566	JZ-23567	JZ-23568
					
JZ-23569	JZ-23570	JZ-23571	JZ-23572	JZ-23573	JZ-23574
					
JZ-23575	JZ-23576	JZ-23577	JZ-23578	JZ-23579	
					
JZ-23580	JZ-23581	JZ-23582	JZ-23583	JZ-23584	

JUKI
7700/7800



JZ-23592



JZ-23593



JZ-23594



JZ-23595



JZ-23596



JZ-23597



JZ-23598



JZ-23599



JZ-23600



JZ-23601



JZ-23602



JZ-23603



JZ-23604



JZ-23605



JZ-23606



JZ-23607



JZ-23608



JZ-23609



JZ-23610



JZ-23611



JZ-23612



JZ-23613



JZ-23614



JZ-23615



JZ-23616



JZ-23617



JZ-23618



JZ-23619



JZ-23620



JZ-23621



JZ-23622



JZ-23623



JZ-23624



JZ-23625



JZ-23626



JZ-23627



JZ-23628



JZ-23629



JZ-23630



JZ-23631



JZ-23632



JZ-23633



JZ-23634



JZ-23635



JZ-23636



JZ-23637



JZ-23638



JZ-23639



JZ-23640



JZ-23641



JZ-23642



JZ-23643



JZ-23644



JZ-23645



JZ-23646



JZ-23647



JZ-23648



JZ-23649



JZ-23650



JZ-23651



JZ-23652



JZ-23653



JZ-23654



JZ-23655



JZ-23656



JZ-23657



JZ-23658



JZ-23659



JZ-23660



JZ-23661



JZ-23663



JZ-23664



JZ-23665



JZ-23662



JZ-23666

**JUKI
8700**



JZ-22011



JZ-22012



JZ-22013



JZ-22014



JZ-22015



JZ-22131 JZ-22132



JZ-22133 JZ-22134



JZ-22068 JZ-22069



JZ-22070 JZ-22071



JZ-22074



JZ-22075 JZ-22076



JZ-22016



JZ-22017



JZ-22018



JZ-22019



JZ-22020



JZ-22021



JZ-22022



JZ-22023



JZ-22024



JZ-22025



JZ-22026



JZ-22027



JZ-22028



JZ-22029



JZ-22030



JZ-22031



JZ-22032



JZ-22033



JZ-22034



JZ-22035



JZ-22036



JZ-22037



JZ-22038



JZ-22039



JZ-22040



JZ-22041



JZ-22042-A



JZ-22043



JZ-22044



JZ-22045



JZ-22046



JZ-22047



JZ-22048



JZ-22049



JZ-22050



JZ-22051 JZ-22052

JZ-22053 JZ-22054



JZ-22055



JZ-22056



JZ-22057



JZ-22058



JZ-22059



JZ-22060



JZ-22066



JZ-22067



JZ-22061

JZ-22062

JZ-22063

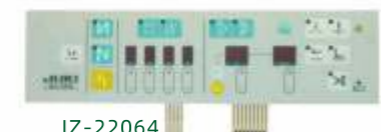

JZ-22064



JZ-22065



JZ-22077



JZ-22080
JZ-22081 JZ-22082



JZ-22083 JZ-22084



JZ-22085



JZ-22086



JZ-22087



JZ-22088



JZ-22089



JZ-22091



JZ-22092



JZ-22093



JZ-22094



JZ-22090

JZ-22095



JZ-22096



JZ-22097



JZ-22098



JZ-22099



JZ-22100



JZ-22101



JZ-22102



JZ-22103



JZ-22104 JZ-22105



JZ-22106



JZ-22107



JZ-22108



JZ-22109



JZ-22110



JZ-22111



JZ-22112



JZ-22113



JZ-22114



JZ-22115



JZ-22116



JZ-22117



JZ-22118



JZ-22119

JZ-22121

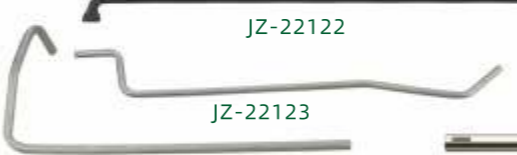

JZ-22122

JZ-22123

JZ-22124

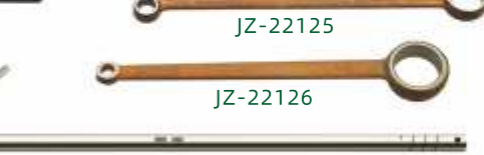

JZ-22125

JZ-22126

JZ-22127



JZ-22128

JZ-22129



JZ-22135



JZ-22136

JZ-22137



JZ-22138

JZ-22143



JZ-22141

JZ-22144



JZ-22140



JZ-22142

JUKI
522



JUKI
重机 3168



JUKI
重机双针 515



JZ-22405



JZ-22410



JZ-22415



JZ-22420



JZ-22425



JZ-22430



JZ-22435



JZ-22439



JZ-22440



JZ-22441



JZ-22442



JZ-22443



JZ-22447



JZ-22448



JZ-22449



JZ-22450



JZ-22451



JZ-22401



JZ-22406



JZ-22402



JZ-22407



JZ-22411



JZ-22416



JZ-22412



JZ-22417



JZ-22421



JZ-22422



JZ-22426



JZ-22427



JZ-22431



JZ-22432



JZ-22436



JZ-22437



JZ-22403



JZ-22408



JZ-22413



JZ-22418



JZ-22423



JZ-22428



JZ-22433



JZ-22438



JZ-22444



JZ-22445



JZ-22446



JZ-22452



JZ-22453



JZ-22454



JZ-22404



JZ-22409



JZ-22414



JZ-22419



JZ-22424



JZ-22429



JZ-22434

JUKI
1790



JZ-22568



JZ-22574



JZ-22579



JZ-22580



JZ-22581



JZ-22585 1790 SET



JZ-22586 29珠



JZ-22587 25珠



JZ-22588 18珠

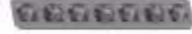

JZ-22589 7珠



JZ-22590 6珠



JZ-22591 5珠

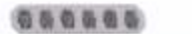

B2513-215-000



JZ-22563



JZ-22569



JZ-22575



JZ-22564



JZ-22570



JZ-22576



JZ-22582



JZ-22565



JZ-22571



JZ-22577



JZ-22566



JZ-22572



JZ-22578



JZ-22567



JZ-22573



JZ-22583



JZ-22584



JZ-22592



JZ-22593



JZ-22594

JZ-22595 5珠

JZ-22596 6珠

JZ-22597 15珠

JZ-22598 19珠

JZ-22599 23珠

JZ-22600 31珠

JUKI

重机 1790



JZ-22601 JZ-22602



JZ-22603



JZ-22604 JZ-22605



JZ-22606



JZ-22607



JZ-22608 JZ-22609



JZ-22610



JZ-22611



JZ-22612



JZ-22613



JZ-22614



JZ-22615



JZ-22616



JZ-22617



JZ-22618



JZ-22619



JZ-22620



JZ-22621



JZ-22622



JZ-22623



JZ-22624



JZ-22625



JZ-22626



JZ-22627



JZ-22628



JZ-22629



JZ-22630



JZ-22631



JZ-22632



JZ-22633



JZ-22634



JZ-22635



JZ-22636



JZ-22637



JZ-22638



JZ-22639



JZ-22640



JZ-22641



JZ-22642



JZ-22643



JZ-22644



JZ-22645



JZ-22646



JZ-22647



JZ-22648



JZ-22649



JZ-22650



JZ-22651



JZ-22652



JZ-22653



JZ-22654



JZ-22655



JZ-22656



JZ-22657



JZ-22658



JZ-22659



JZ-22660



JZ-22661



JZ-22662



JZ-22663



JZ-22664



JZ-22665



JZ-22666



JZ-22667



JZ-22668



JZ-22669



JZ-22670



JZ-22671



JZ-22672



JZ-22673



JZ-22674



JZ-22675



JZ-22676



JZ-22677



JZ-22678



JZ-22679



JZ-22680



JZ-22681



JZ-22682



JZ-22683



JZ-22684



JZ-22685



JZ-22686



JZ-22687



JZ-22688

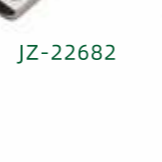

JZ-22689



JZ-22690

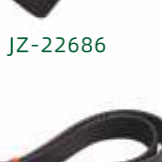

JZ-22691



JZ-22692



JZ-22693



JZ-22694



JZ-22695

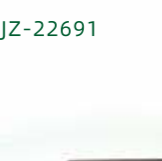

JZ-22696



JZ-22697

JUKI
重机 210D

JZ-22801

JZ-22802

JZ-22803

JZ-22804

JZ-22805

JZ-22848

JZ-22849

JZ-22850

JZ-22851

JZ-22852

JZ-22853

JZ-22806

JZ-22807

JZ-22808

JZ-22809

JZ-22810

JZ-22811

JZ-22854

JZ-22855

JZ-22856

JZ-22857

JZ-22858

JZ-22859

JZ-22812

JZ-22813

JZ-22814

JZ-22815

JZ-22816

JZ-22817

JZ-22860

JZ-22861

JZ-22862

JZ-22863

JZ-22864

JZ-22865

JZ-22818

JZ-22819

JZ-22820

JZ-22821

JZ-22822

JZ-22823

JZ-22866

JZ-22867

JZ-22868

JZ-22869

JZ-22870

JZ-22871

JZ-22824

JZ-22825

JZ-22826

JZ-22827

JZ-22828

JZ-22829

JZ-22872

JZ-22873

JZ-22874

JZ-22875

JZ-22876

JZ-22877

JZ-22830

JZ-22831

JZ-22832

JZ-22833

JZ-22834

JZ-22835

JZ-22878

JZ-22885

JZ-22889

JZ-22879

JZ-22886

JZ-22890

JZ-22836

JZ-22837

JZ-22838

JZ-22839

JZ-22840

JZ-22841

JZ-22880

JZ-22887

JZ-22891

JZ-22842

JZ-22843

JZ-22844

JZ-22845

JZ-22846

JZ-22847

JZ-22881

JZ-22882

JZ-22883

JZ-22884

JZ-22888

JZ-22892

brother
电脑平车 101/735



brother
7200



brother
430



JZ-25301



JZ-25302



JZ-25303



JZ-25304



JZ-25305



JZ-25347



JZ-25348



JZ-25349



JZ-25350



JZ-25351



JZ-25352



JZ-25306



JZ-25307



JZ-25308



JZ-25309



JZ-25310



JZ-25311



JZ-25353



JZ-25354



JZ-25355



JZ-25356



JZ-25357



JZ-25358



JZ-25312



JZ-25313



JZ-25314



JZ-25315



JZ-25316



JZ-25317



JZ-25359



JZ-25360



JZ-25361



JZ-25362



JZ-25363



JZ-25364



JZ-25318



JZ-25319



JZ-25320



JZ-25321



JZ-25322



JZ-25323



JZ-25365



JZ-25366



JZ-25367



JZ-25368



JZ-25369



JZ-25370



JZ-25324



JZ-25325



JZ-25326



JZ-25327



JZ-25328



JZ-25329



JZ-25371



JZ-25372



JZ-25373



JZ-25374



JZ-25375



JZ-25376



JZ-25330



JZ-25331



JZ-25332



JZ-25333



JZ-25334



JZ-25335



JZ-25377



JZ-25378



JZ-25379



JZ-25380



JZ-25381



JZ-25382



JZ-25336



JZ-25337



JZ-25338



JZ-25339



JZ-25342



JZ-25343



JZ-25344



JZ-25345



JZ-25346



JZ-25383



JZ-25384



JZ-25385



JZ-25386



JZ-25387



JZ-25388



JZ-25340



JZ-25341



JZ-25389



JZ-25390



JZ-25391



JZ-25392

brother
430D



JZ-25442



JZ-25443



JZ-25444



JZ-25445



JZ-25446



JZ-25447



JZ-25448



JZ-25449



JZ-25450



JZ-25451



JZ-25452



JZ-25453



JZ-25454



JZ-25455



JZ-25456



JZ-25457



JZ-25458



JZ-25459



JZ-25460



JZ-25461



JZ-25462



JZ-25463



JZ-25464



JZ-25465



JZ-25466



JZ-25467



JZ-25468



JZ-25469



JZ-25470

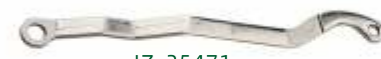

JZ-25471



JZ-25477



JZ-25479



JZ-25472



JZ-25473



JZ-25478



JZ-25480



JZ-25474



JZ-25481



JZ-25475



JZ-25482



JZ-25476



JZ-25483



JZ-25484



JZ-25485



JZ-25486



JZ-25487



JZ-25488



JZ-25489



JZ-25490



JZ-25491



JZ-25492



JZ-25493



JZ-25494



JZ-25495



JZ-25496



JZ-25497



JZ-25498



JZ-25499



JZ-25500



JZ-25501



JZ-25502



JZ-25503



JZ-25504



JZ-25505



JZ-25506



JZ-25507



JZ-25508



JZ-25509



JZ-25510



JZ-25511



JZ-23512



JZ-25513



JZ-25514



JZ-25515



JZ-25516



JZ-25517



JZ-25518



JZ-25519



JZ-25520



JZ-25521



JZ-25522



JZ-25523



JZ-25524



JZ-25525

brother 814



brother
814

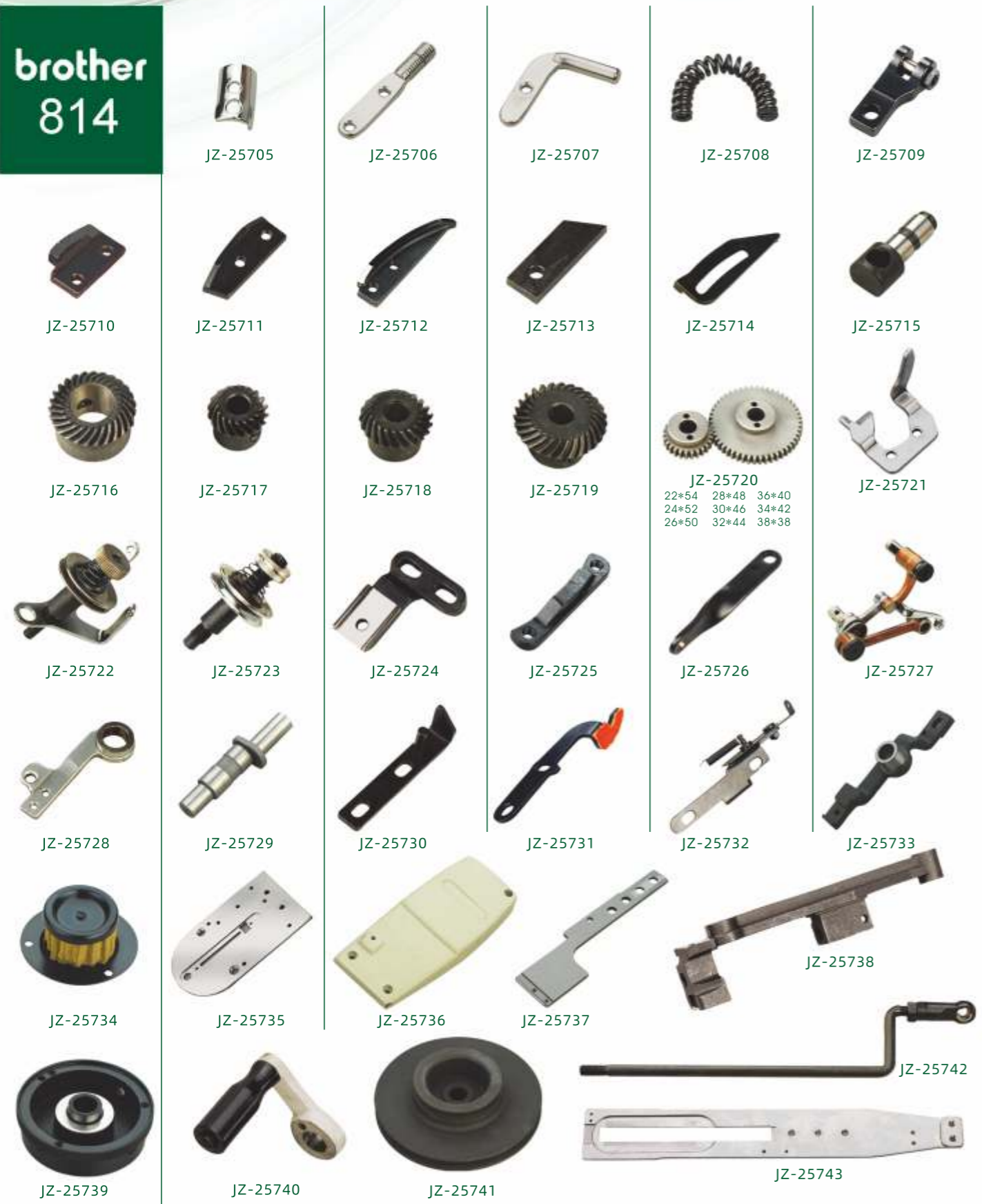

brother
兄弟双针 845



brother
兄弟 917



JZ-25892



JZ-25893



JZ-25894



JZ-25895



JZ-25896



JZ-25937



JZ-25938



JZ-25939



JZ-25940



JZ-25941



JZ-25942



JZ-25897



JZ-25898



JZ-25899



JZ-25900



JZ-25901



JZ-25902



JZ-25943



JZ-25944



JZ-25945



JZ-25946



JZ-25947



JZ-25948



JZ-25903



JZ-25904



JZ-25905



JZ-25906



JZ-25907



JZ-25908



JZ-25949



JZ-25950



JZ-25951



JZ-25952



JZ-25953



JZ-25954



JZ-25909



JZ-25910



JZ-25911



JZ-25912



JZ-25913



JZ-25914



JZ-25955



JZ-25956



JZ-25957



JZ-25958



JZ-25959



JZ-25960



JZ-25915



JZ-25916



JZ-25917



JZ-25918



JZ-25919



JZ-25920



JZ-25961



JZ-25962



JZ-25963



JZ-25964



JZ-25965



JZ-25966



JZ-25921



JZ-25922



JZ-25923



JZ-25924



JZ-25925



JZ-25926



JZ-25967



JZ-25968



JZ-25969



JZ-25970



JZ-25971



JZ-25972



JZ-25927



JZ-25928



JZ-25929



JZ-25930



JZ-25931



JZ-25932



JZ-25973



JZ-25974



JZ-25975



JZ-25976



JZ-25977



JZ-25978



JZ-25933



JZ-25934



JZ-25935



JZ-25936



JZ-25979



JZ-25980



JZ-25981



JZ-25982



JZ-25983

**brother
927、928**

 JZ-26051	 JZ-26052	 JZ-26053	 JZ-26054	 JZ-26055	 JZ-26106	 JZ-26107	 JZ-26108	 JZ-26109	 JZ-26110	 JZ-26111				
 JZ-26056	 JZ-26057	 JZ-26058	 JZ-26059	 JZ-26060	 JZ-26061	 JZ-26062	 JZ-26063	 JZ-26064	 JZ-26112	 JZ-26113	 JZ-26114	 JZ-26115	 JZ-26116	 JZ-26117
 JZ-26065	 JZ-26066	 JZ-26067	 JZ-26068	 JZ-26069	 JZ-26070	 JZ-26118	 JZ-26119	 JZ-26120	 JZ-26121	 JZ-26122	 JZ-26123			
 JZ-26071	 JZ-26072	 JZ-26073	 JZ-26074	 JZ-26075	 JZ-26076	 JZ-26124	 JZ-26125	 JZ-26126	 JZ-26127	 JZ-26128	 JZ-26129			
 JZ-26077	 JZ-26078	 JZ-26079	 JZ-26080	 JZ-26081	 JZ-26082	 JZ-26083	 JZ-26084	 JZ-26085	 JZ-26130	 JZ-26131	 JZ-26132	 JZ-26133	 JZ-26134	 JZ-26135
 JZ-26086	 JZ-26087	 JZ-26088	 JZ-26089	 JZ-26090	 JZ-26091	 JZ-26136	 JZ-26137	 JZ-26138	 JZ-26139	 JZ-26140	 JZ-26141			
 JZ-26092	 JZ-26093	 JZ-26094	 JZ-26095	 JZ-26096	 JZ-26097	 JZ-26098	 JZ-26099	 JZ-26100	 JZ-26101	 JZ-26102	 JZ-26103	 JZ-26104	 JZ-26105	
 JZ-26143	 JZ-26144	 JZ-26145	 JZ-26146	 JZ-26147	 JZ-26148	 JZ-26149	 JZ-26150	 JZ-26151	 JZ-26152					

brother
9810
9820



JZ-26211



JZ-26212



JZ-26213



JZ-26214



JZ-26215



JZ-26216



JZ-26217



JZ-26218



JZ-26219



JZ-26220



JZ-26221



JZ-26222



JZ-26223



JZ-26224



JZ-26225



JZ-26226



JZ-26227



JZ-26228



JZ-26229



JZ-26230



JZ-26231



JZ-26232



JZ-26233



JZ-26234



JZ-26235



JZ-26236



JZ-26237



JZ-26238



JZ-26239



JZ-26240



JZ-26241



JZ-26242



JZ-26243



JZ-26244



JZ-26245



JZ-26246



JZ-26247



JZ-26248



JZ-26249



JZ-26250



JZ-26251



JZ-26252



JZ-26253



JZ-26254



JZ-26255



JZ-26256



JZ-26257



JZ-26258



JZ-26259



JZ-26260



JZ-26261



JZ-26262



JZ-26263



JZ-26264



JZ-26265



JZ-26266



JZ-26267



JZ-26268



JZ-26269



JZ-26270



JZ-26271



JZ-26272



JZ-26273



JZ-26274



JZ-26275



JZ-26276



JZ-26277



JZ-26278



JZ-26279



JZ-26280



JZ-26281



JZ-26282



JZ-26283



JZ-26284



JZ-26285



JZ-26286



JZ-26287



JZ-26288



JZ-26289



JZ-26290



JZ-26291

brother
9810
9820



JZ-26292



JZ-26293



JZ-26294



JZ-26295



JZ-26296



JZ-26297



JZ-26298



JZ-26299



JZ-26300



JZ-26301



JZ-26302



JZ-26303



JZ-26304



JZ-26305



JZ-26306



JZ-26307



JZ-26308



JZ-26309



JZ-26310



JZ-26311



JZ-26312



JZ-26313



JZ-26314



JZ-26315



JZ-26316



JZ-26317



JZ-26318



JZ-26319



JZ-26320



JZ-26321



JZ-26322



JZ-26323



JZ-26324



JZ-26325



JZ-26326



JZ-26327



JZ-26328



JZ-26329



JZ-26330



JZ-26331



JZ-26332



JZ-26333



JZ-26334



JZ-26335



JZ-26336



JZ-26337



JZ-26338



JZ-26339



JZ-26340



JZ-26341



JZ-26342



JZ-26343



JZ-26344



JZ-26345



JZ-26346



JZ-26347



JZ-26348



JZ-26349



JZ-26350



JZ-26351



JZ-26352



JZ-26353



JZ-26354



JZ-26355



JZ-26356



JZ-26357



JZ-26358



JZ-26359



JZ-26360



JZ-26361



JZ-26362



JZ-26363



JZ-26364



JZ-26365



JZ-26366



JZ-26367



JZ-26368



JZ-26369



JZ-26370



JZ-26374



JZ-26375



JZ-26376



JZ-26377



JZ-26378



JZ-26370



JZ-26371

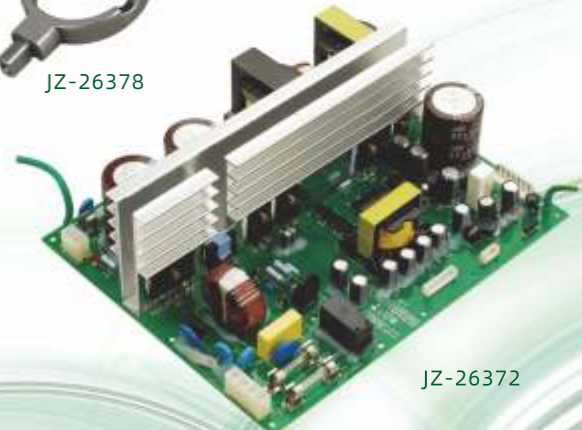

JZ-26372

brother 531、551



brother 兄弟 N31



brother HE800A



PEGASUS
M800



JZ-29801



JZ-29802



JZ-29803



JZ-29804



JZ-29805



JZ-29806



JZ-29807



JZ-29808



JZ-29809



JZ-29810



JZ-29811



JZ-29812



JZ-29813



JZ-29814



JZ-29815



JZ-29816



JZ-29817



JZ-29818



JZ-29819



JZ-29820



JZ-29821



JZ-29822



JZ-29823



JZ-29824



JZ-29825



JZ-29826



JZ-29827



JZ-29828



JZ-29829



JZ-29830



JZ-29831



JZ-29832



JZ-29833



JZ-29834



JZ-29835



JZ-29836



JZ-29837



JZ-29838



JZ-29839



JZ-29840



JZ-29841



JZ-29842



JZ-29843



JZ-29844



JZ-29845



JZ-29846

JINZEN®

有一种经营叫规模
上万个缝纫零部件及附件
为全球客户的长久服务...
一起成就着金振的规模产业!

PEGASUS
M600



JZ-30001



JZ-30002



JZ-30003 JZ-30004



JZ-30005



JZ-30006



JZ-30048



JZ-30049



JZ-30050



JZ-30051



JZ-30052



JZ-30053



JZ-30007



JZ-30008



JZ-30009



JZ-30010



JZ-30011



JZ-30012



JZ-30054



JZ-30055



JZ-30056



JZ-30057



JZ-30058



JZ-30059



JZ-30013



JZ-30014



JZ-30015



JZ-30016



JZ-30017



JZ-30018



JZ-30060



JZ-30061



JZ-30062



JZ-30063



JZ-30064



JZ-30065



JZ-30019



JZ-30020



JZ-30021



JZ-30022



JZ-30023



JZ-30024



JZ-30066



JZ-30067



JZ-30068



JZ-30069



JZ-30070



JZ-30071



JZ-30025



JZ-30026



JZ-30027



JZ-30028



JZ-30029



JZ-30030



JZ-30072



JZ-30073



JZ-30074



JZ-30075



JZ-30076



JZ-30077



JZ-30031



JZ-30032



JZ-30033



JZ-30034



JZ-30035



JZ-30036



JZ-30078



JZ-30079



JZ-30080



JZ-30081



JZ-30082



JZ-30083



JZ-30037



JZ-30038



JZ-30039



JZ-30040



JZ-30041



JZ-30042



JZ-30084



JZ-30085



JZ-30086



JZ-30087



JZ-30091



JZ-30043



JZ-30044



JZ-30045



JZ-30046



JZ-30047



JZ-30088



JZ-30089



JZ-30090



JZ-30092

JZ-30093

PEGASUS M700



JZ-30151



JZ-30152



JZ-30153



JZ-30154



JZ-30155



JZ-30196



JZ-30197



JZ-30198



JZ-30199



JZ-30200



JZ-30201



JZ-30156



JZ-30157



JZ-30158



JZ-30159



JZ-30160



JZ-30161



JZ-30162



JZ-30163



JZ-30164



JZ-30165



JZ-30166



JZ-30167



JZ-30168



JZ-30169



JZ-30170



JZ-30171



JZ-30172



JZ-30173



JZ-30174



JZ-30175



JZ-30176



JZ-30177



JZ-30178



JZ-30179



JZ-30180



JZ-30181



JZ-30182



JZ-30183



JZ-30184



JZ-30185



JZ-30186



JZ-30187



JZ-30188



JZ-30189



JZ-30190



JZ-30191



JZ-30192



JZ-30193



JZ-30195



JZ-30243



JZ-30238



JZ-30239



JZ-30240



JZ-30241



JZ-30242



JZ-30226



JZ-30232



JZ-30227



JZ-30233



JZ-30228



JZ-30234



JZ-30229



JZ-30235



JZ-30230



JZ-30236



JZ-30231



JZ-30237



JZ-30220



JZ-30221



JZ-30222



JZ-30223



JZ-30224



JZ-30225



JZ-30214



JZ-30215



JZ-30216



JZ-30217



JZ-30218



JZ-30219



JZ-30208



JZ-30209



JZ-30210



JZ-30211



JZ-30212



JZ-30213



JZ-30202



JZ-30203



JZ-30204



JZ-30205



JZ-30206



JZ-30207

**PEGASUS
W500**

 JZ-30295	 JZ-30290	 JZ-30291	 JZ-30292	 JZ-30293	 JZ-30294	 JZ-30339	 JZ-30340	 JZ-30341	 JZ-30342	 JZ-30343	 JZ-30344
 JZ-30301	 JZ-30296	 JZ-30297	 JZ-30298	 JZ-30299	 JZ-30300	 JZ-30345	 JZ-30346	 JZ-30347	 JZ-30348	 JZ-30349	 JZ-30350
 JZ-30307	 JZ-30302	 JZ-30303	 JZ-30304	 JZ-30305	 JZ-30306	 JZ-30351	 JZ-30352	 JZ-30353	 JZ-30354	 JZ-30355	 JZ-30356
 JZ-30314	 JZ-30308	 JZ-30309	 JZ-30310	 JZ-30311	 JZ-30312	 JZ-30357	 JZ-30358	 JZ-30359	 JZ-30360	 JZ-30361	 JZ-30362
 JZ-30320	 JZ-30315	 JZ-30316	 JZ-30317	 JZ-30318	 JZ-30319	 JZ-30363	 JZ-30364	 JZ-30365	 JZ-30366	 JZ-30367	 JZ-30368
 JZ-30326	 JZ-30321	 JZ-30322	 JZ-30323	 JZ-30324	 JZ-30325	 JZ-30369	 JZ-30370	 JZ-30371	 JZ-30372	 JZ-30373	 JZ-30374
 JZ-30332	 JZ-30327	 JZ-30328	 JZ-30329	 JZ-30330	 JZ-30331	 JZ-30375	 JZ-30376	 JZ-30377	 JZ-30378	 JZ-30379	 JZ-30380
 JZ-30336	 JZ-30333	 JZ-30334	 JZ-30335	 JZ-30338	 JZ-30381	 JZ-30382	 JZ-30383	 JZ-30384	 JZ-30385	 JZ-30386	
 JZ-30337	 JZ-30390	 JZ-30391			 JZ-30387	 JZ-30388	 JZ-30389				

**PEGASUS
W664**



JZ-30441



JZ-30442



JZ-30443



JZ-30444



JZ-30445



JZ-30446



JZ-30447



JZ-30448



JZ-30449



JZ-30450



JZ-30451



JZ-30452



JZ-30453



JZ-30454



JZ-30455



JZ-30456



JZ-30457



JZ-30458



JZ-30459



JZ-30460



JZ-30461



JZ-30462



JZ-30463



JZ-30464



JZ-30465



JZ-30466



JZ-30467



JZ-30468



JZ-30469



JZ-30470



JZ-30471



JZ-30472



JZ-30473



JZ-30474



JZ-30475



JZ-30476



JZ-30478

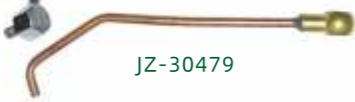

JZ-30479



JZ-30481



JZ-30482



JZ-30483



JZ-30484



JZ-30485



JZ-30486



JZ-30487



JZ-30488



JZ-30489



JZ-30490



JZ-30491



JZ-30492



JZ-30493



JZ-30494



JZ-30495



JZ-30496



JZ-30497



JZ-30498



JZ-30499



JZ-30500



JZ-30501



JZ-30502



JZ-30503



JZ-30504



JZ-30505



JZ-30506



JZ-30507



JZ-30508



JZ-30509



JZ-30510



JZ-30511



JZ-30512



JZ-30513



JZ-30514



JZ-30515



JZ-30516



JZ-30517



JZ-30518



JZ-30519



JZ-30520



JZ-30521



JZ-30523



JZ-30525



JZ-30528



JZ-30529



JZ-30522



JZ-30524



JZ-30526



JZ-30527



JZ-30530

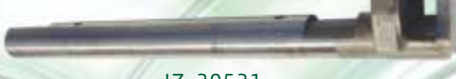

JZ-30531

PEGASUS
EX3200
EX5100
MX3200

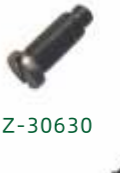

PEGASUS
EX3200
EX5100
MX3200



SIRUBA
VC008



SIRUBA

F007、C007



JZ-35001



JZ-35002



JZ-35003 JZ-35004



JZ-35005



JZ-35006



JZ-35047



JZ-35048



JZ-35049



JZ-35050



JZ-35051



JZ-35052 JZ-35053



JZ-35007



JZ-35008



JZ-35009



JZ-35010



JZ-35011



JZ-35012



JZ-35054



JZ-35055



JZ-35056



JZ-35057



JZ-35058



JZ-35059



JZ-35013



JZ-35014



JZ-35015



JZ-35016



JZ-35017



JZ-35018



JZ-35060



JZ-35061



JZ-35062



JZ-35063



JZ-35064



JZ-35065



JZ-35019



JZ-35020



JZ-35021



JZ-35022



JZ-35023



JZ-35024



JZ-35025



JZ-35026



JZ-35027



JZ-35028



JZ-35029



JZ-35030



JZ-35073



JZ-35074



JZ-35075



JZ-35076



JZ-35077



JZ-35078



JZ-35031



JZ-35032



JZ-35033



JZ-35034



JZ-35035



JZ-35036



JZ-35079



JZ-35080



JZ-35081



JZ-35082



JZ-35083



JZ-35084



JZ-35037



JZ-35038



JZ-35039



JZ-35040



JZ-35041



JZ-35042



JZ-35085



JZ-35086



JZ-35087



JZ-35088



JZ-35089



JZ-35090



JZ-35043



JZ-35044



JZ-35045



JZ-35046



JZ-35091



JZ-35092



JZ-35093



JZ-35094



JZ-35095

SIRUBA
747/757



JZ-35151



JZ-35152



JZ-35153



JZ-35154



JZ-35155



JZ-35156



JZ-35157



JZ-35158



JZ-35159



JZ-35160



JZ-35161



JZ-35162



JZ-35163



JZ-35164



JZ-35165



JZ-35166



JZ-35167



JZ-35168



JZ-35169



JZ-35170



JZ-35171



JZ-35172



JZ-35173



JZ-35174



JZ-35175



JZ-35176



JZ-35177



JZ-35178



JZ-35179



JZ-35180



JZ-35181



JZ-35182



JZ-35183



JZ-35184



JZ-35185



JZ-35186



JZ-35187



JZ-35188



JZ-35189



JZ-35190



JZ-35191



JZ-35192



JZ-35193



JZ-35194



JZ-35195



JZ-35196



JZ-35197



JZ-35198



JZ-35199



JZ-35200



JZ-35201



JZ-35202



JZ-35203



JZ-35204



JZ-35205



JZ-35206



JZ-35207



JZ-35208



JZ-35209



JZ-35210



JZ-35211



JZ-35212



JZ-35213



JZ-35214



JZ-35215



JZ-35216



JZ-35217



JZ-35218



JZ-35219



JZ-35220



JZ-35221



JZ-35222



JZ-35223



JZ-35224



JZ-35225



JZ-35226



JZ-35227



JZ-35228



JZ-35229



JZ-35236



JZ-35237



JZ-35238



JZ-35230



JZ-35231



JZ-35234



JZ-35235



JZ-35239



JZ-35241



JZ-35240



JZ-35232



JZ-35233



JZ-35235



JZ-35241

SIRUBA

988



JZ-35346



JZ-35347



JZ-35348



JZ-35349



JZ-35394



JZ-35395



JZ-35396































































































JZ-35397



JZ-35398

Kingtex
宝狮 SH7000

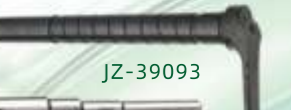
	 JZ-39001	 JZ-39002	 JZ-39003	 JZ-39004	 JZ-39005		 JZ-39047	 JZ-39048	 JZ-39049	 JZ-39050	 JZ-39051	 JZ-39052
 JZ-39006	 JZ-39007	 JZ-39008	 JZ-39009	 UL603886	 5212LL0002		 JZ-39053	 JZ-39054	 JZ-39055	 JZ-39056	 JZ-39057	 JZ-39058
 JZ-39012	 JZ-39013	 JZ-39014	 JZ-39015	 JZ-39016	 JZ-39017		 JZ-39059	 JZ-39060	 JZ-39061	 JZ-39062	 JZ-39063	 JZ-39064
 JZ-39018	 JZ-39019	 JZ-39020	 JZ-39021	 JZ-39022	 JZ-39023		 JZ-39065	 JZ-39066	 JZ-39067	 JZ-39068	 JZ-39069	 JZ-39070
 JZ-39024	 JZ-39025	 JZ-39026	 JZ-39027	 JZ-39028	 JZ-39029		 JZ-39071	 JZ-39072	 JZ-39073	 JZ-39074	 JZ-39075	 JZ-39076
 JZ-39030	 JZ-39031	 JZ-39032	 JZ-39033	 JZ-39034	 JZ-39035		 JZ-39077	 JZ-39078	 JZ-39079	 JZ-39080	 JZ-39081	 JZ-39082
 JZ-39036	 JZ-39037	 JZ-39038	 JZ-39039	 JZ-39040	 JZ-39041		 JZ-39083	 JZ-39084	 JZ-39085	 JZ-39086	 JZ-39087	 JZ-39088
 JZ-39042	 JZ-39043	 JZ-39044	 JZ-39045	 JZ-39046			 JZ-39089	 JZ-39090	 JZ-39091	 JZ-39092	 JZ-39093	

KANSAI

关西 1404



JZ-40001



JZ-40002



JZ-40003



JZ-40004



JZ-40005



JZ-40047 JZ-40048



JZ-40049 JZ-40050



JZ-40051



JZ-40052



JZ-40053



JZ-40054



JZ-40006



JZ-40007



JZ-40008



JZ-40009



JZ-40010



JZ-40011



JZ-40055



JZ-40056



JZ-40057



JZ-40058



JZ-40059



JZ-40060



JZ-40012



JZ-40013



JZ-40014



JZ-40015



JZ-40016



JZ-40017



JZ-40061



JZ-40062



JZ-40063



JZ-40064



JZ-40065



JZ-40066



JZ-40018



JZ-40019



JZ-40020



JZ-40021



JZ-40022



JZ-40023



JZ-40024



JZ-40025



JZ-40026



JZ-40027



JZ-40028



JZ-40029



JZ-40067



JZ-40068



JZ-40069



JZ-40070



JZ-40071



JZ-40072



JZ-40030



JZ-40031



JZ-40032



JZ-40033



JZ-40034



JZ-40035



JZ-40036



JZ-40039



JZ-40040



JZ-40041



JZ-40042



JZ-40044



JZ-40045



JZ-40037



JZ-40043



JZ-40046



JZ-40038



JZ-40047



JZ-40049



JZ-40051



JZ-40052



JZ-40053



JZ-40054



JZ-40055



JZ-40056



JZ-40057



JZ-40058



JZ-40059



JZ-40060



JZ-40061



JZ-40062



JZ-40063



JZ-40064



JZ-40065



JZ-40066



JZ-40067



JZ-40068



JZ-40069



JZ-40070



JZ-40071



JZ-40072



JZ-40073



JZ-40074



JZ-40075



JZ-40076



JZ-40077



JZ-40078



JZ-40079



JZ-40080



63-711
JZ-40081



JZ-40082



63-713
JZ-40096



63-621
JZ-40097



JZ-40083



JZ-40084



JZ-40085



JZ-40086



JZ-40087



JZ-40088



JZ-40089 JZ-40090



JZ-40092



JZ-40094



JZ-40095



JZ-40098



JZ-40099

KANSAI

关西 1508



JZ-40151



JZ-40152



JZ-40153



JZ-40154



JZ-40155



JZ-40156



JZ-40157



JZ-40158



JZ-40159



JZ-40160



JZ-40161



JZ-40162



JZ-40163



JZ-40164



JZ-40165



JZ-40166



JZ-40167



JZ-40168



JZ-40169



JZ-40170



JZ-40171



JZ-40172



JZ-40173



JZ-40174



JZ-40175



JZ-40176



JZ-40177



JZ-40178



JZ-40179



JZ-40180



JZ-40185



JZ-40186



JZ-40187



JZ-40188



JZ-40181



JZ-40182



JZ-40189



JZ-40191



JZ-40192



JZ-40193



JZ-40183



JZ-40184



JZ-40190



JZ-40194

JZ-40195



JZ-40196

KANSAI

关西 33 针



JZ-40301



JZ-40302



JZ-40303



JZ-40304



JZ-40305



JZ-40306



JZ-40307



JZ-40308



JZ-40309



JZ-40310



JZ-40311



JZ-40312



JZ-40313



JZ-40314



JZ-40315



JZ-40316



JZ-40317



JZ-40318



JZ-40319



JZ-40320



JZ-40321



JZ-40322



JZ-40323



JZ-40324



JZ-40325



JZ-40326



JZ-40327



JZ-40328



JZ-40329



JZ-40330



JZ-40331



JZ-40332



JZ-40333



JZ-40334



JZ-40335



JZ-40336



JZ-40501



JZ-40502



JZ-40503



JZ-40504



JZ-40505



JZ-40506

Iyamato
 大和 AZ8500

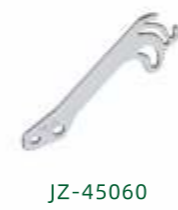

Yamato 大和 1500



JZ-45091



JZ-45092



JZ-45093



JZ-45094



JZ-45095 JZ-45096



JZ-45097



JZ-45098



JZ-45099



JZ-45100



JZ-45101



JZ-45102



JZ-45103



JZ-45104



JZ-45105



JZ-45106



JZ-45107



JZ-45108



JZ-45109



JZ-45110



JZ-45111



JZ-45112



JZ-45113



JZ-45114



JZ-45115



JZ-45116



JZ-45117



JZ-45118



JZ-45119



JZ-45120



JZ-45121



JZ-45122



JZ-45123



JZ-45124



JZ-45125



JZ-45126



JZ-45128



JZ-45131



JZ-45133



JZ-45129



JZ-45134



JZ-45127



JZ-45130



JZ-45132



JZ-45135



JZ-45136



JZ-45137



JZ-45138



JZ-45139



JZ-45140



JZ-45141



JZ-45142



JZ-45143



JZ-45144



JZ-45145



JZ-45146



JZ-45147



JZ-45148



JZ-45149



JZ-45150



JZ-45151



JZ-45152



JZ-45153



JZ-45154



JZ-45155



JZ-45156



JZ-45157



JZ-45158



JZ-45159



JZ-45160



JZ-45161



JZ-45162



JZ-45163



JZ-45164



JZ-45165



JZ-45166



JZ-45167



JZ-45168



JZ-45169



JZ-45170



JZ-45172



JZ-45173



JZ-45174



JZ-45175



JZ-45176



JZ-45177

JZ-45178



JZ-45179



JZ-45180



JZ-45181



JZ-45182

Ijamato
大和 1500



Ijamato
大和 2500



Ijamato

大和 2500
大和 2700



Ijamato

VG3721



Ujamoto
四针六线



Ujamoto

FD-62G-01MR

JZ-45742

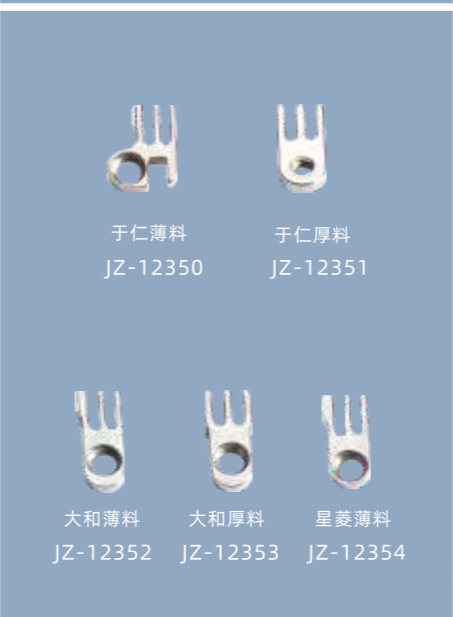

PEGASUS

FS700

JZ-45743



SHING LING

SL-700

JZ-45744



SHING LING
星菱777



SHING LING
星菱777

SHING LING
星菱SL700





JZ-49001

JZ-49002

JZ-49003

JZ-49004

JZ-49005

JZ-49048

JZ-49049

JZ-49050

JZ-49051

JZ-49052

JZ-49053

JZ-49006

JZ-49007

JZ-49008

JZ-49009

JZ-49010

JZ-49011

JZ-49054

JZ-49055

JZ-49056

JZ-49057

JZ-49058

JZ-49059

JZ-49012

JZ-49013

JZ-49014

JZ-49015

JZ-49016

JZ-49017

JZ-49060

JZ-49061

JZ-49062

JZ-49063

JZ-49064

JZ-49065

JZ-49018

JZ-49019

JZ-49020

JZ-49021

JZ-49022

JZ-49023

JZ-49066

JZ-49067

JZ-49068

JZ-49069

JZ-49070

JZ-49071

JZ-49024

JZ-49025

JZ-49026

JZ-49027

JZ-49028

JZ-49029

JZ-49072

JZ-49073

JZ-49074

JZ-49075

JZ-49076

JZ-49077

JZ-49030

JZ-49031

JZ-49032

JZ-49033

JZ-49034

JZ-49035

JZ-49078

JZ-49079

JZ-49080

JZ-49081

JZ-49082

JZ-49083

JZ-49036

JZ-49037

JZ-49038

JZ-49039

JZ-49040

JZ-49041

JZ-49084

JZ-49085

JZ-49088

JZ-49042

JZ-49043

JZ-49044

JZ-49045

JZ-49046

JZ-49047

JZ-49089

JZ-49090

JZ-49093

JZ-49091

JZ-49092

SINGER
胜家 20U



JZ-51001



JZ-51002



JZ-51003



JZ-51004



JZ-51005



JZ-51047



JZ-51048



JZ-51049



JZ-51050



JZ-51052



JZ-51053



JZ-51006



JZ-51007



JZ-51008



JZ-51009



JZ-51010



JZ-51011



JZ-51054



JZ-51055



JZ-51056



JZ-51057



JZ-51058



JZ-51059



JZ-51012



JZ-51013



JZ-51014



JZ-51015



JZ-51016



JZ-51017



JZ-51060



JZ-51061



JZ-51062



JZ-51063



JZ-51064



JZ-51065



JZ-51018



JZ-51019



JZ-51020



JZ-51021



JZ-51022



JZ-51023



JZ-51066



JZ-51067



JZ-51068



JZ-51069



JZ-51070



JZ-51071



JZ-51024



JZ-51025



JZ-51026



JZ-51027



JZ-51028



JZ-51029



JZ-51072



JZ-51073



JZ-51074



JZ-51075



JZ-51076



JZ-51077



JZ-51030



JZ-51031



JZ-51036



JZ-51037



JZ-51043



JZ-51032



JZ-51033



JZ-51034



JZ-51035



JZ-51078



JZ-51079



JZ-51080



JZ-51081



JZ-51082



JZ-51083



JZ-51038



JZ-51039



JZ-51040



JZ-51041



JZ-51084



JZ-51085



JZ-51086



JZ-51087



JZ-51088



JZ-51089



JZ-51094



JZ-51090

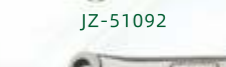

JZ-51092



JZ-51093



JZ-51095



JZ-51042

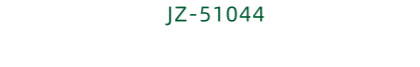

JZ-51044



JZ-51045



JZ-51046



JZ-51096

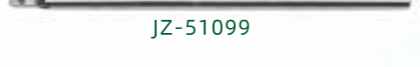

JZ-51099

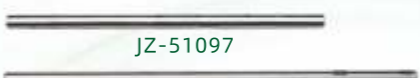

JZ-51097



JZ-51100



JZ-51098



JZ-51101

NEWLONG NP-7 GK26



PFAFF 百福 335

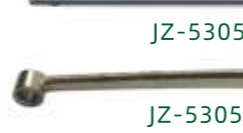
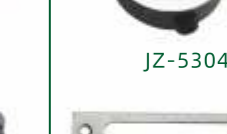
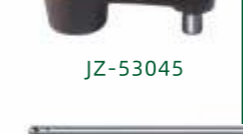
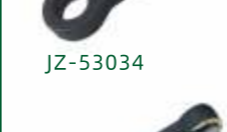
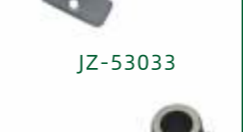
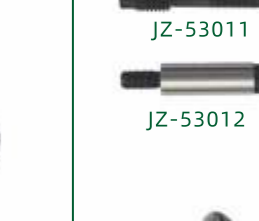
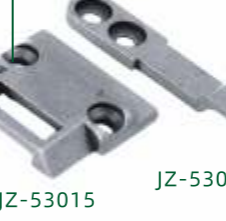
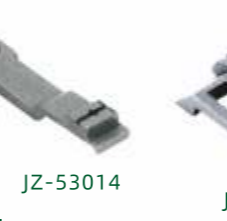

高头车
810.820

 JZ-54001	 JZ-54002	 JZ-54003	 JZ-54004	 JZ-54005	 JZ-54006	 JZ-54060	 JZ-54061	 JZ-54062	 JZ-54063	 JZ-54064	 JZ-54065	 JZ-54066
 JZ-54007	 JZ-54008	 JZ-54009	 JZ-54010	 JZ-54011	 JZ-54012	 JZ-54067	 JZ-54068	 JZ-54069	 JZ-54070	 JZ-54071	 JZ-54072	
 JZ-54013	 JZ-54014	 JZ-54015	 JZ-54016	 JZ-54017	 JZ-54018	 JZ-54073	 JZ-54074	 JZ-54075	 JZ-54076	 JZ-54077	 JZ-54078	
 JZ-54019	 JZ-54020	 JZ-54021	 JZ-54022	 JZ-54023	 JZ-54024	 JZ-54079	 JZ-54080	 JZ-54081	 JZ-54082	 JZ-54083	 JZ-54084	
 JZ-54025	 JZ-54026	 JZ-54027	 JZ-54028	 JZ-54029	 JZ-54030	 JZ-54085	 JZ-54086	 JZ-54087	 JZ-54088	 JZ-54089	 JZ-54090	
 JZ-54031	 JZ-54032	 JZ-54033	 JZ-54034	 JZ-54035	 JZ-54036	 JZ-54093	 JZ-54093	 JZ-54093	 JZ-54116	 JZ-54116	 JZ-54116	
 JZ-54037	 JZ-54038	 JZ-54039	 JZ-54040	 JZ-54041	 JZ-54042	 JZ-54043	 JZ-54044	 JZ-54095	 JZ-54096	 JZ-54097	 JZ-54098	 JZ-54099
 JZ-54045	 JZ-54046	 JZ-54047	 JZ-54048	 JZ-54049	 JZ-54050	 JZ-54055	 JZ-54056	 JZ-54095	 JZ-54096	 JZ-54097	 JZ-54098	 JZ-54099
 JZ-54048	 JZ-54049	 JZ-54050	 JZ-54051	 JZ-54052	 JZ-54053	 JZ-54057	 JZ-54058	 JZ-54100	 JZ-54101	 JZ-54102	 JZ-54103	 JZ-54104
 JZ-54049	 JZ-54053	 JZ-54057	 JZ-54058	 JZ-54059	 JZ-54059	 JZ-54109	 JZ-54110	 JZ-54111	 JZ-54113	 JZ-54113	 JZ-54115	 JZ-54115

罗拉车
591



罗拉车
9901

							
JZ-55008	JZ-55001	JZ-55002	JZ-55003	JZ-55004 JZ-55005	JZ-55006 JZ-55007		
							
JZ-55015	JZ-55009 JZ-55010	JZ-55011	JZ-55012	JZ-55013	JZ-55014		
							
JZ-55021	JZ-55016	JZ-55017	JZ-55018	JZ-55019	JZ-55020		
							
JZ-55027	JZ-55022	JZ-55023	JZ-55024	JZ-55025	JZ-55026		
							
JZ-55035	JZ-55028	JZ-55029	JZ-55030	JZ-55031	JZ-55032		
						2.0 2.4 2.8 3.2	
JZ-55036	JZ-55033	JZ-55041	JZ-55040	JZ-55039	JZ-55045		
						JZ-55047 (2.0 / 2.4 / 2.8 / 3.2)	
JZ-55042	JZ-55038 RUBBER	JZ-55043	JZ-55044	JZ-55046	JZ-55047 (2.0 / 2.4 / 2.8 / 3.2)		

TYPICAL

标准 341

					
JZ-55206	JZ-55207	JZ-55208	JZ-55209	JZ-55210	JZ-55211
					
JZ-55212	JZ-55213	JZ-55214	JZ-55215	JZ-55216	JZ-55217
					
JZ-55218	JZ-55219	JZ-55220	JZ-55221	JZ-55222	JZ-55223
					
JZ-55224	JZ-55225	JZ-55226	JZ-55227	JZ-55228	JZ-55229
					
JZ-55230	JZ-55231	JZ-55232	JZ-55233	JZ-55234	JZ-55235
					
JZ-55236	JZ-55237	JZ-55238	JZ-55239	JZ-55240	JZ-55241
					
JZ-55242	JZ-55243	JZ-55244	JZ-55245	JZ-55246	
					
JZ-55247	JZ-55248	JZ-55249	JZ-55250	JZ-55251	JZ-55252
					
JZ-55253	JZ-55254			JZ-55253	JZ-55254

TYPICAL
标准
0302/0318



JZ-55301

JZ-55302

JZ-55303

JZ-55304

JZ-55305

JZ-55346

JZ-55347

JZ-55348

JZ-55349

JZ-55350

JZ-55351

JZ-55306

JZ-55307

JZ-55308

JZ-55309

JZ-55310

JZ-55311

JZ-55352

JZ-55353

JZ-55354

JZ-55355

JZ-55356

JZ-55357

JZ-55312

JZ-55313

JZ-55314

JZ-55315

JZ-55316

JZ-55317

JZ-55358

JZ-55359

JZ-55360

JZ-55361

JZ-55362

JZ-55363

JZ-55318

JZ-55319

JZ-55320

JZ-55321

JZ-55322

JZ-55323

JZ-55364

JZ-55365

JZ-55366

JZ-55367

JZ-55368

JZ-55369

JZ-55324

JZ-55325

JZ-55326

JZ-55327

JZ-55328

JZ-55329

JZ-55370

JZ-55371

JZ-55372

JZ-55373

JZ-55374

JZ-55375

JZ-55330

JZ-55331

JZ-55332

JZ-55333

JZ-55334

JZ-55335

JZ-55376

JZ-55377

JZ-55378

JZ-55379

JZ-55380

JZ-55381

JZ-55336

JZ-55341

JZ-55342

JZ-55343

JZ-55386

JZ-55387

JZ-55337

JZ-55338

JZ-55339

JZ-55340

JZ-55344

JZ-55345

JZ-55382

JZ-55383

JZ-55384

JZ-55385

JZ-55388

JZ-55389

JZ-55390

JZ-55391

精工
8B



SINGER
胜家 591



削皮机
801



Eastman

伊士曼电剪



kmsh
KM 电剪



JZ-58001



JZ-58002 JZ-58003



JZ-58004 JZ-58005

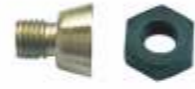

JZ-58006 JZ-58007



JZ-58008



JZ-58009



JZ-58010



JZ-58011



JZ-58012



JZ-58013



JZ-58014



JZ-58015



JZ-58016



JZ-58017



JZ-58018



JZ-58019



JZ-58020



JZ-58021



JZ-58022



JZ-58023



JZ-58024



JZ-58025



JZ-58026 JZ-58027

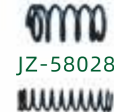

JZ-58028

JZ-58029



JZ-58030

JZ-58031



JZ-58032



JZ-58033



JZ-58034



JZ-58035



JZ-58097



JZ-58036



JZ-58038



JZ-58039



JZ-58040



JZ-58041



JZ-58042



JZ-58043



JZ-58044



JZ-58045



JZ-58046



JZ-58047



JZ-58048



JZ-58049
(5" 8" 10")



JZ-58050



JZ-58051



JZ-58052



JZ-58053



JZ-58054 JZ-58094



JZ-58055



JZ-58056



JZ-58057



JZ-58058



JZ-58060



JZ-58061



JZ-58062 JZ-58063



JZ-58064



JZ-58065



JZ-58066



JZ-58067



JZ-58068



JZ-58069



JZ-58070



JZ-58071



JZ-58072



JZ-58073



JZ-58074



JZ-58075



JZ-58076



JZ-58077



JZ-58078



JZ-58079



JZ-58080



JZ-58081



JZ-58083



JZ-58084



JZ-11301

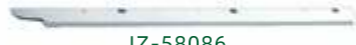

JZ-58086



JZ-58087

(5" 8" 10")



JZ-58088

(5" 8" 10")



JZ-58089

(5" 8" 10")



JZ-58090

(5" 8" 10")



JZ-58091

(5" 8" 10")



JZ-58085



JZ-58095



JZ-58096



JZ-58092
(5" 8" 10")

断布机



JZ-59001



JZ-59002



JZ-59003



JZ-59004



JZ-59005



JZ-59006



JZ-59007



JZ-59008



JZ-59009



JZ-59010



JZ-59011



JZ-59012



JZ-59013



JZ-59014



JZ-59015



JZ-59016



JZ-59017



JZ-59018



JZ-59019



JZ-59020



JZ-59021



JZ-59023



JZ-59022



JZ-59024



JZ-59025



JZ-59028



JZ-59026



JZ-59027

圆刀机
RS-90
RS-100



JZ-60007 JZ-60008



JZ-72409 JZ-60014



JZ-60021 JZ-60022



JZ-60026



JZ-60032



JZ-60038



JZ-60043



JZ-60009



JZ-60015



JZ-60023
RS90



JZ-60027



JZ-60033



JZ-60039



JZ-60044



JZ-60002



JZ-60010



JZ-60016



JZ-60049
RS100 火连



JZ-60028



JZ-60034



JZ-60040



JZ-60045



JZ-60003



JZ-60011



JZ-60017



JZ-60050
RS100 乐江



JZ-60029



JZ-60035



JZ-60041



JZ-60046



JZ-60004 JZ-60005



JZ-60012



JZ-60019



JZ-60024
RS100



JZ-60030



JZ-60036



JZ-60042



JZ-60047



JZ-60006



JZ-60013



JZ-60020



JZ-60025
RS100



JZ-60031



JZ-60037



JZ-60042



JZ-60047



JINZEN®
胶订机 JZ-9000



JZ-62020



胶订机
JZ-9000



家用机
 JA1-1
 JA2-1



JZ-63001



JZ-63002



JZ-63003



JZ-63004



JZ-63005



JZ-63048



JZ-63049



JZ-63050



JZ-63051



JZ-63052



JZ-63053



JZ-63006



JZ-63007



JZ-63008



JZ-63009



JZ-63010



JZ-63011



JZ-63054



JZ-63055



JZ-63056



JZ-63057



JZ-63058



JZ-63059



JZ-63012



JZ-63013



JZ-63014



JZ-63015



JZ-63016



JZ-63017



JZ-63060



JZ-63061



JZ-63062



JZ-63063



JZ-63064



JZ-63065



JZ-63018



JZ-63019



JZ-63020



JZ-63021



JZ-63022



JZ-63023



JZ-63066



JZ-63067



JZ-63068



JZ-63069



JZ-63070



JZ-63071



JZ-63024



JZ-63026



JZ-63027



JZ-63028



JZ-63029

Ø111
 Ø115
 Ø118
 Ø120
 Ø123
 Ø131



JZ-63093

MB350
 MB360
 M7370
 MB380
 MB390
 MB400
 MB420



JZ-63072

JZ-63075



JZ-63073

JZ-63076



JZ-63074

JZ-63077



JZ-63030



JZ-63031



JZ-63032



JZ-63033



JZ-63034



JZ-63035



JZ-63078



JZ-63079



JZ-63080



JZ-63081



JZ-63082



JZ-63083



JZ-63036



JZ-63037



JZ-63038



JZ-63039



JZ-63040



JZ-63041



JZ-63084



JZ-63086



JZ-63087



JZ-63094



JZ-63092



JZ-63042



JZ-63043



JZ-63044



JZ-63045



JZ-63046



JZ-63047



JZ-63089



JZ-63090



JZ-63091



JZ-63094



JZ-63092

家用机
多功能
307



JZ-63301 JZ-63302 JZ-63303 JZ-63304 JZ-63305
 JZ-63306 JZ-63307 JZ-63308 JZ-63309 JZ-63310 JZ-63311
 JZ-63312 JZ-63313 JZ-63314 JZ-63315 JZ-63316 JZ-63317
 JZ-63318 JZ-63319 JZ-63320 JZ-63321 JZ-63322 JZ-63323
 JZ-63324 JZ-63325 JZ-63326 JZ-63327 JZ-63328 JZ-63329
 JZ-63330 JZ-63331 JZ-63332 JZ-63333 JZ-63334 JZ-63335
 JZ-63336 JZ-63337 JZ-63338 JZ-63339 JZ-63371 JZ-63372



JZ-63340 JZ-63341 JZ-63342 JZ-63343 JZ-63344 JZ-63345
 JZ-63346 JZ-63347 JZ-63348 JZ-63349 JZ-63350 JZ-63351
 JZ-63352 JZ-63353 JZ-63354 JZ-63355 JZ-63356 JZ-63357
 JZ-63358 JZ-63359 JZ-63360 JZ-63361 JZ-63362 JZ-63363
 JZ-63364 JZ-63365 JZ-63366 JZ-63367 JZ-63374
 JZ-63368 JZ-63373 JZ-63375 JZ-63384
 JZ-63369 JZ-63370
 JZ-63377 E12 JZ-63378 BA15D JZ-63379 E14 JZ-63381 E12 LED JZ-63382 E14 LED JZ-63383 BA15D LED JZ-63380

SINGER
胜家
974



JZ-63506



JZ-63512



JZ-63518



JZ-63524



JZ-63530



JZ-63536



JZ-63501



JZ-63507



JZ-63513



JZ-63519



JZ-63525



JZ-63531



JZ-63537



JZ-63502



JZ-63508



JZ-63514



JZ-63520



JZ-63526



JZ-63532



JZ-63538



JZ-63503



JZ-63509



JZ-63515



JZ-63521



JZ-63527



JZ-63533



JZ-63539



JZ-63504



JZ-63510



JZ-63516



JZ-63522



JZ-63528



JZ-63534



JZ-63540



JZ-63505



JZ-63511



JZ-63517



JZ-63523



JZ-63529



JZ-63535



JZ-63541



JZ-63545



JZ-63546



JZ-63547



JZ-63544



JZ-63548



JZ-63542



JZ-63543



JZ-63549



JZ-63555



JZ-63561



JZ-63567



JZ-63587



JZ-63550



JZ-63556



JZ-63562



JZ-63568



JZ-63573



JZ-63578



JZ-63551



JZ-63557



JZ-63563



JZ-63569



JZ-63574



JZ-63579



JZ-63583



JZ-63584



JZ-63588



JZ-63552



JZ-63558



JZ-71343



JZ-63570



JZ-63575



JZ-63580



JZ-63585



JZ-63553



JZ-63559



JZ-71342



JZ-63571



JZ-63576



JZ-63581



JZ-63586



JZ-63554



JZ-63560



JZ-63566



JZ-63572



JZ-63577



JZ-63582



JZ-63589

brother
多功能
5500



JZ-64001



JZ-64002



JZ-64003



JZ-64004



JZ-64005



JZ-64006



JZ-64007



JZ-64008



JZ-64009



JZ-64010



JZ-64011



JZ-64012



JZ-64013



JZ-64014



JZ-64015



JZ-64016



JZ-64017



JZ-64018



JZ-64019



JZ-64020



JZ-64021



JZ-64022



JZ-64023



JZ-64024



JZ-64025



JZ-64026



JZ-64027



JZ-64029



JZ-64030



JZ-64031



JZ-64032



JZ-64033



JZ-64034



JZ-64035



JZ-64036



JZ-64037



JZ-64038



JZ-64039



JZ-64040



JZ-64041



JZ-64042



JZ-64043



JZ-64044



JZ-64045



JZ-64046



JZ-64047



JZ-64048



JZ-64049



JZ-64050



JZ-64051

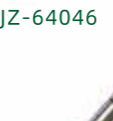

JZ-64052

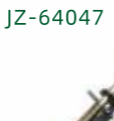

JZ-64053



JZ-64054



JZ-64055



JZ-64056



JZ-64057



JZ-64058



JZ-64059



JZ-64060



JZ-64061



JZ-64062



JZ-64063



JZ-64064



JZ-64065



JZ-64066



JZ-64067



JZ-64068



JZ-64069



JZ-64070



JZ-64071



JZ-64072



JZ-64073



JZ-64074



JZ-64075



JZ-64076



JZ-64077



JZ-64078



JZ-64079



JZ-64080



JZ-64081



JZ-64082



JZ-64083



JZ-64084



JZ-64085



JZ-64086



JZ-64087



JZ-64088



JZ-64089



JZ-64090



JZ-64091



JZ-64092



JZ-64093



JZ-64094



JZ-64095



JZ-64096

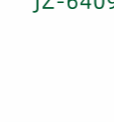

JZ-64097



JZ-64098

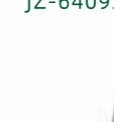

JZ-64099



JZ-64098



JZ-64099



JZ-64100

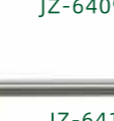

JZ-64101



JZ-64102



JZ-64103

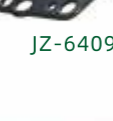

JZ-64104

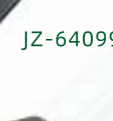

JZ-64105



JZ-64105

JANOME

真善美

2049



JZ-65001



JZ-65002



JZ-65003



JZ-65004



JZ-65005



JZ-65048



JZ-65049



JZ-65050



JZ-65051



JZ-65052



JZ-65053



JZ-65006



JZ-65007



JZ-65008



JZ-65009



JZ-65010



JZ-65011



JZ-65054



JZ-65055



JZ-65056



JZ-65057



JZ-65058



JZ-65059



JZ-65012



JZ-65013



JZ-65014



JZ-65015



JZ-65016



JZ-65017



JZ-65060



JZ-65061



JZ-65062



JZ-65063



JZ-65064



JZ-65065



JZ-65018



JZ-65019



JZ-65020



JZ-65021



JZ-65022



JZ-65023



JZ-65066



JZ-65067



JZ-65068



JZ-65069



JZ-65070



JZ-65072



JZ-65024



JZ-65025



JZ-65026



JZ-65027



JZ-65028



JZ-65029



JZ-65073



JZ-65074



JZ-65075



JZ-65076



JZ-65077



JZ-711335



JZ-65030



JZ-65031



JZ-65032



JZ-65033



JZ-65034



JZ-65035



JZ-65078



JZ-65080



JZ-65081



JZ-65079



JZ-65082



JZ-65083



JZ-65036



JZ-65037



JZ-65038



JZ-65039



JZ-65040



JZ-65041



JZ-65089
SHX3 2#
SHX3 3#
SHX3 4#



JZ-65090 2054 12#
2054 14#
2054 16#



JZ-65091 2045 12#
2045 14#
2045 16#



JZ-11513 HAX1 11#
HAX1 12#
HAX1 14#
HAX1 16#
HAX1 18#



JZ-65042



JZ-65043



JZ-65044



JZ-65045



JZ-65046



JZ-65047



JZ-65084



JZ-65086

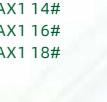

JZ-65093

暗缝机



大白扣机



修边机



JACK 杰克



家用多功能压脚

Sewing Machine Feet & Accessory For Household



JZ-66000

15-PIECE STANDARD FEET SET
Item RJ-215

JZ-66001

8-PIECE UTILITY FEET PACKAGE
Item RJ-208

JZ-66002

JZ-66003













































JZ-66004



JZ-66005

JINZEN®

家用多功能压脚
Sewing Machine Feet
& Accessory For Household

 57015 JZ-66006	 5701L JZ-66007	 601Z CONCEALED ZIPPER FOOT JZ-66008	 7315 5 GROOVE PINTUCK FOOT JZ-66009	 7315W 9 GROOVE PINTUCK JZ-66010	 601ZN CONCEALED ZIPPER FOOT JZ-66011
 20000 2008 PIPING FOOT JZ-66012	 20000 3009 GATHERING FOOT JZ-66013	 7309 CORDING FOOT JZ-66014	 7313 OPEN TOE FOOT JZ-66015	 7320 BRADING FOOT JZ-66016	 7323 ZIGZAG FOOT JZ-66017
 161956 JZ-66018	 384119-457 JZ-66019	 153267 STRAIGHT STITCH FOOT JZ-66020	 5012-1 JZ-66021	 7306-2 ZIPPER FOOT JZ-66022	 7307R ROLLER HEM FOOT JZ-66023
 155962 JZ-66024	 7306 ZIPPER FOOT JZ-66025	 7309W CORDING FOOT 7MM JZ-66026	 446371 ZIGZAG FOOT JZ-66027	 7317 DITCH/EDGE JOINING FOOT JZ-66028	 7319 PATCHWORK FOOT JZ-66029
 7301 ZIGZAG FOOT JZ-66030	 7301W 7MM ZIGZAG FOOT JZ-66031	 7301G AIGZAG FOOT JZ-66032	 7301-2 ZIGZAG FOOT JZ-66033	 7301SS ZIGZAG JZ-66034	 7304 STRAIGHT STITCH JZ-66035
 7301 NG ZIGZAG FOOT NO GROOVE JZ-66036	 7322 PATCHWCRK FOOT 1/4" STRAIGHT STITCH JZ-66037	 7318 DITCH EDGE TOHINING FOOT JZ-66038	 7310 OVERCASTING PLATE JZ-66039	 7307 HEMMER FOOT JZ-66040	 7307WR ROLLER HEM FOOT 7MM JZ-66041
 P55607 JZ-66042	 7325 JZ-66043	 7306 ZIPPER FOOT JZ-66025	 7321-1 (JARAME) JZ-66045	 7321 JZ-66046	 7326 OVERCASTING PLATE JZ-66047

家用多功能压脚

Sewing Machine Feet & Accessory For Household

JINZEN®

 701L 5 GROOVE LOW SHANK PINTUCK FOOT JZ-66048	 702 GATHERING FOOT JZ-66049	 601 LZN LOW SHANK CONCEALED ZIPPER FOOT JZ-66050	 716LW 7MM GORDING FOOT LOW SHANK JZ-66051	 720L-NLT ZIGZAG JZ-66052	 720LW 7MM LOW SHANK ZIGZAG FOOT JZ-66053	 40986X6 1/4" JZ-66084	 40986X6 3/16" JZ-66085	 40986X6 1/8" JZ-66086	 801+7301-2 SRT2 ZIGZAG FOOT JZ-66087	 8034 FOR COMPINTER SEWING ZIGZAG JZ-66088	 8012 FOR COMPUTER SEWING ZIGZAG JZ-66089
 720L LOW SHANK ZIGZAG FOOT JZ-66054	 718L OPEN TOE FOOT LOW SHANK JZ-66055	 719L STRAIGHT JZ-66056	 1895 DARNING FOOT JZ-66057	 717H HIGH SHANK HEMMER JZ-66058	 717LR ROLLER HEM FOOT LOW SHANK JZ-66059	 7316 ZIGZAG FOOT JZ-66090	 701M DARNING FOOT JZ-66091	 701 DARNING FOOT LOW SHANK JZ-66092	 7308 BLIND STITCH JZ-66093	 723L BLIND STITCH LOW SHANK JZ-66094	 PART # 29309 HOLDER JZ-66095
 717-1L ROLLER HEM FOOT LOW SHANK JZ-66060	 7322S SLANT 1/4IN STRAIGHT STITCH JZ-66061	 717L HEMMER LOW SHANK JZ-66062	 720H-NG HIGH SHANK ZIGZAG FOOT JZ-66063	 720H HIGH SHANK ZIGZAG FOOT JZ-66064	 718H HIGH SHANK OPEN TOE FOOT JZ-66065	 73081 BLIND STITCH FOOT JZ-66096	 6290 TAPE BINDE JZ-66097	 6287 LOW SHANK TAPE BINDING JZ-66098	 4021-BP DARNING FOOT JZ-66099	 4021L DARNING FOOT JZ-66100	 4021L-OT OPEN TOE DARNING FOOT JZ-66101
 712 LOW SHANK 10MM JZ-66066	 713 12MM JZ-66067	 710 LOW SHANK JZ-66068	 PART # 25910 LOW SHANK GATHERING FOOT JZ-66069	 711 LOW SHANK JZ-66070	 709 LOW SHANK JZ-66071	 P60410 LOW SHANK FREE-MOTION JZ-66102	 P60417 FREE MOTION DARNING FOOT (SLANT) JZ-66103	 4021P FREE MOTION DARNING FOOT JZ-66104	 4021P-H HIGH SHANK FREE MOTION DARNING JZ-66105	 4021HP DARNING FOOT HIGH SHANK JZ-66106	 161876-1 DARNING FOOT JZ-66107
 707 LOW SHANK GATHERING FOOT JZ-66072	 707R LOW SHANK GATHERING FOOT JZ-66073	 707S SLANT GATHERING FOOT JZ-66074	 725 STRAIGHT STITCH JZ-66075	 PART # 39196 OVERCASTING FOOT LOW SHANK JZ-66076	 714 HIGH SHANK JZ-66077	 PART # 29301 1/4" HEMMER JZ-66108	 PART # 29302 1/4" HEMMER JZ-66109	 PART # 29303 1/8" HEMMER JZ-66110	 PART # 29304 5/8" HEMMER JZ-66111	 29305 7/8" HEMMER JZ-66112	 29306 ELAS HEMMER JZ-66113
 720H-SS HIGH SHANK ZIGZAG JZ-66078	 2555 LOW SHANK JZ-66079	 717-1S ROLLER HEM FOOT SLANT JZ-66080	 7321L LOW SHANK JZ-66081	 7321H HIGH SHANK JZ-66082	 717-1H ROLLER HEM FOOT HIGH SHANK JZ-66083	 29307+29309 BINDER JZ-66114	 720HP HIGH SHANK ZIGZAG FOOT JZ-66115	 720LP LOW SHANK ZIGZAG FOOT JZ-66116	 P60791 LOW SHANK OPEN TOE FOOT JZ-66117	 PART # 35852 GUIDE JZ-66118	 ANT1 NEEDLE THREADER JZ-66119

家用多功能
压脚



542167
JZ-66120



155964
JZ-66121



7300
HOLDER
JZ-66122



7300J
LOW SHANK
HOLDER
JZ-66123



7300H
HIGH SHANK
HOLDER
JZ-66124



507836
JZ-66125



171480
ZIPPER FOOT FOR SLANT
JZ-66126



7305
BUTTON SEW ON
JZ-66127



A9
APPLIQUE FOOT
JZ-66128



446498
JZ-66129



601
CONCEALED ZIPPER FOOT
JZ-66130



7301T
ZIGZAG FOOT 7MM
(TELFON)
JZ-66131



7301PW
ZIGZAG FOOT
JZ-66132



7301P
ZIGZAG FOOT 5MM
JZ-66133



7303W
SATIN STITCH 7MM
JZ-66134



7303 5MM
SATIN STITCH FOOT
JZ-66135



7324
WELTING/BRADING FOOT
JZ-66136



7314W
ROLLER FOOT 7MM
JZ-66137



7314
ROLLER FOOT 5MM
JZ-66138



P60794W
OPEN TOE FOOT
JZ-66139



506377
JZ-66140



7322P
1/4IN FOOT
JZ-66141



602
STRAIGHT STITCH
JZ-66142



720LPW
ZIGZAG LOW SHANK
JZ-66143



721L
5MM SOE IN STITCH FOOT
LOW SHANK
JZ-66144



5615
SATIN STITCH LOW SHANK
JZ-66145



722H
ROLLER FOOT HIGH SHANK
JZ-66146



722S
ROLLER FOOT SLANT
JZ-66147



P60793
OPEN TOE FOOT SLANT
JZ-66148



721H
SATIN STITCH FOOT
HIGH SHANK
JZ-66149



5554
SATIN STITCH HIGH SHANK
JZ-66150



708
BUTTON SEW ON
JZ-66151



7305L
LOW SHANK
BUTTON SEW ON
JZ-66152



PART # 54612
DARNING FOOT
JZ-66153



7322SP
SLANT
1/4" STRAIGHT STITCH
JZ-66154



703LI
BUTTONHDE FOOT
JZ-66155



313992
BUTTONHDE FOOT
JZ-66156



703L
BUTTONHDE FOOT
LOW SHANK
JZ-66157



7302
BUTTONHDE
JZ-66158



1932S
BUTTONHDE FOOT
SLANT
JZ-66159



706L
LOW SHANK
ADJUSTABLE ZIPPER
JZ-66160



706S
SLANT
ADJUSTABLE ZIPPER
JZ-66161



706H
HIGH SHANK
ADJUSTABLE ZIPPER
JZ-66162



705LI
LOW SHANK
ADJUSTABLE ZIPPER
JZ-66163



705L
LOW SHANK
ADJUSTABLE ZIPPER
JZ-66164



705H
HIGH SHANK
ADJUSTABLE ZIPPER
JZ-66165



551
LOW SHANK
ADJUSTABLE ZIPPER
JZ-66166



PART # 6792
ADJUSTABLE ZIPPER
JZ-66167



6792-1
ZIPPER(TELFON)
JZ-66168



Q04
QUILTING GUIDE
JZ-66169



RJ-7322LQ4
HIGH QUILTING FEET
JZ-66170

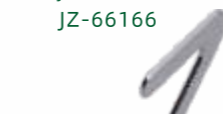

Q01
QUILTING GUIDE
JZ-66171

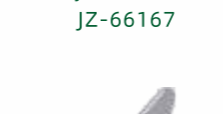

Q02
QUILTING GUIDE
JZ-66172



PART # 17310
QUILTING GUIDE
JZ-66173

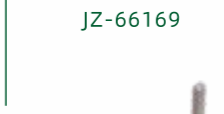

7311
QUILTING GUIDE
JZ-66174



Q03
QUILTING GUIDE
JZ-66175



R1000L
WALKING FOOT
JZ-66176



423242-451
WALKING FOOT
JZ-66177



421333-451
SLANT
JZ-66178



214872011
WALKING FOOT
JZ-66179



P60444W
WALKING FOOT 7MM
JZ-66180



P60444
WALKING FOOT
JZ-66181



YS-7
ZIGZAG ATTACHMENT
JZ-66182



RG-10L
SIDE CUTTER
JZ-66183



55705
JZ-66184



55642
JZ-66185



55642S
JZ-66186

 RJ-604 缝凸压脚 JZ-66187	 RJ-607 刺绣压脚 JZ-66188	 93-036 941-91 缝凸 pfaff JZ-66189	 98-694 864-00 万能 pfaff JZ-66190	 RJ-7314PW 防水布滚轮压脚 JZ-66191	 93-036 84300 JZ-66192
 98-694 884-00 拉链 pfaff JZ-66193	 98-694 884-00 拉链 pfaff JZ-66194	 RJ-601 ZE 隐形拉链压脚 JZ-66195	 RJ-7315W-1 5-groore 定位压脚 JZ-66196	 93-036 931-91 开口 pfaff JZ-66197	 93-036 931-91 开口 pfaff JZ-66198
 4128649-05 1/4" 拼缝 pfaff JZ-66199	 4128649-06 1/4" 拼缝 弹片靠右 JZ-66200	 98-694 890-00 盲缝 pfaff JZ-66201	 4128451 卷缝 pfaff JZ-66202	 98-694 818-00 卷缝 pfaff JZ-66203	 93-036 982-91 纽扣 pfaff JZ-66204
 98-694 814-00 万能 pfaff JZ-66205	 93-036 933-91 开口 pfaff JZ-66206	 93-036 905-91 万能 pfaff JZ-66207	 98-694 828-01 万能 pfaff JZ-66208	 93-036 936-91 绳索 pfaff JZ-66209	 98-694 845-00 盲缝 pfaff JZ-66210
 4128649-04 1/4" 拼缝弹片置中 JZ-66211	 7318BR 拼布压脚 JZ-66212	 808 绳索压脚 JZ-66213	 7317R 边缝压脚 JZ-66214	 7330 雙边缝凸压脚 JZ-66215	 7301SSW 万能压脚 JZ-66216
 7301J 车乐美万能压脚 JZ-66217	 6705 7-groore定位压脚 JZ-66218	 7308W 7mm 盲缝压脚 JZ-66219	 7301-2J 万能压脚 JZ-66220	 7304W-J 车乐美直线压脚 JZ-66221	 7313W 7mm开口压脚 JZ-66222

 7326JK 定位拼布压脚 JZ-66223	 7313D 饰缝压脚 JZ-66224	 806 万能密缝压脚 JZ-66225	 7310BW-E 布边压脚(E) 7mm JZ-66226	 7318R 边缝压脚 JZ-66227	 7312U 拼布压脚 JZ-66228
 7326BR 盲缝压脚 JZ-66229	 7310BW 7mm 布边压脚 JZ-66230	 7310BW-C 布边压脚 (C) JZ-66231	 6708 定规拼布压脚 JZ-66232	 605 定规饰缝压脚 JZ-66233	 SA538 定规器 JZ-66234
 7327 set 8/8 卷布压脚 JZ-66235	 7327 set 6/8 卷布压脚 JZ-66236	 7327 set 4/8 卷布压脚 JZ-66237	 7329 分离式仓边压脚 JZ-66238	 701J 车乐美刺绣压脚 JZ-66239	 93-036 990-91 纽扣孔 pfaff JZ-66240
 7302PG 纽扣孔压脚 JZ-66241	 7302HPHG 纽扣孔压脚 JZ-66242	 21481720514 Low shank 均匀压脚 JZ-66243	 214806008 High shank 均匀压脚 JZ-66244	 JZ-66251	
 1250001-501 JZ-66245	 1250011-501 JZ-66246	 1250021-501 JZ-66247	 671511-DBC10 JZ-66248	 671511-DDD10 JZ-66249	 JZ-66250

JINZEN®

JINZEN® 喷枪是一种先进、高效的去污工具。它适用液体的高压喷射，从而达到去污功能。

金振喷枪技术先进，设计合理，喷射压力高，去污能力强，性能稳定，可靠耐用，

是针织、印染、服装、广告、印花等行业完美的去污工具。



JZ-70001



JZ-70021



JZ-70002



JZ-70003



JZ-70004



JZ-70005



JZ-70006



JZ-70007



JZ-70008



JZ-70009



JZ-70020



JZ-70011



JZ-70012



JZ-70013



JZ-70014



JZ-70015



JZ-70016



JZ-70017



JZ-70018



JZ-70019



JZ-70052



JZ-70051

JINZEN®

IRONS



电加热熨斗

STEAM ELECTRIC IRON



2128 JZ-70100



0010 JZ-70101



310 JZ-70103



ES-94A JZ-70104



ES-94AL JZ-70105



ES-85AF JZ-70089



ES-300 JZ-70090



ES-300L JZ-70091



ES-3200 II JZ-70092



SE-2000N JZ-70093



ST-750 JZ-70115



BS-3PC II JZ-70095



BS-6PC II JZ-70096



BS-8SC JZ-70097



BSP-300 JZ-70098



BSS-600 JZ-70099



600 JZ-70106



610 JZ-70107



300 JZ-70108



BSP-200 JZ-70109



6PC JZ-70110



3PC JZ-70111



2A JZ-70112



600A JZ-70113



9000 JZ-70114

JINZEN® IRONING SHOE 熨斗靴系列



JZ-70281 JZ-70282 JZ-70283 JZ-70284 JZ-70285
 万能熨斗靴 铁氟龙厚度/TEFION THICKNESS: 6/8/10/12mm



JZ-70250 BD2 JZ-70251 320 JZ-70252 B-6T JZ-70253 HD-2003 JZ-70254 420

STEEL
 钢网厚度: 6mm
 TEFION
 THICKNESS
 铁氟龙厚度: 3/5/6mm

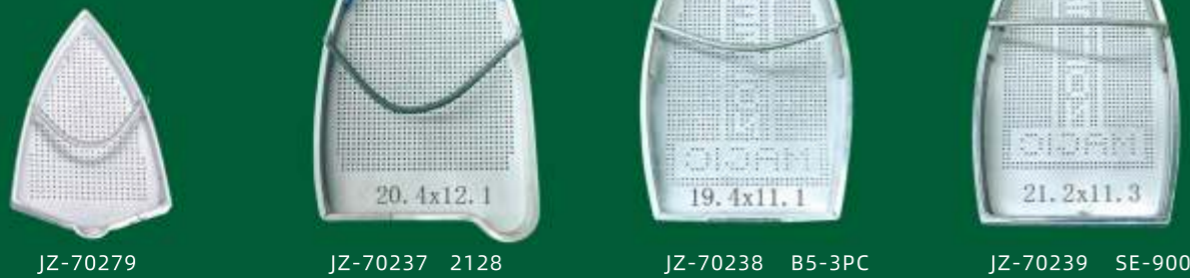

JZ-70279 JZ-70237 2128 JZ-70238 B5-3PC JZ-70239 SE-900

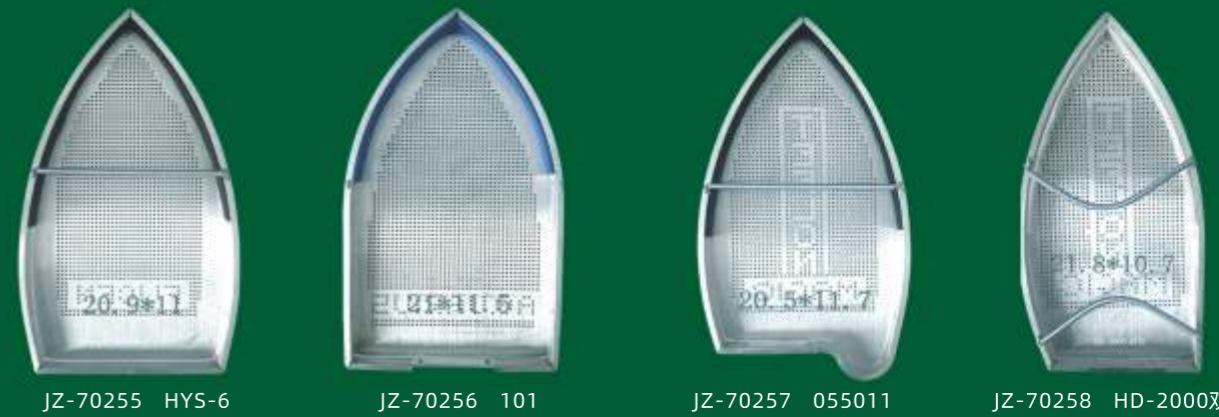

JZ-70255 HYS-6 JZ-70256 101 JZ-70257 055011 JZ-70258 HD-2000双耳

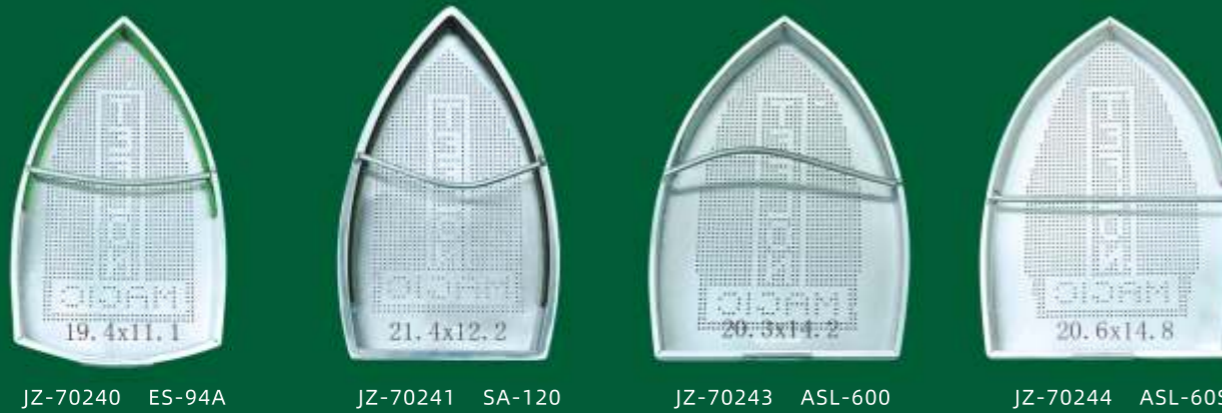

JZ-70240 ES-94A JZ-70241 SA-120 JZ-70243 ASL-600 JZ-70244 ASL-60S



JZ-70259 ES-85AF JZ-70260 60M JZ-70261 50M JZ-70262 SA-110

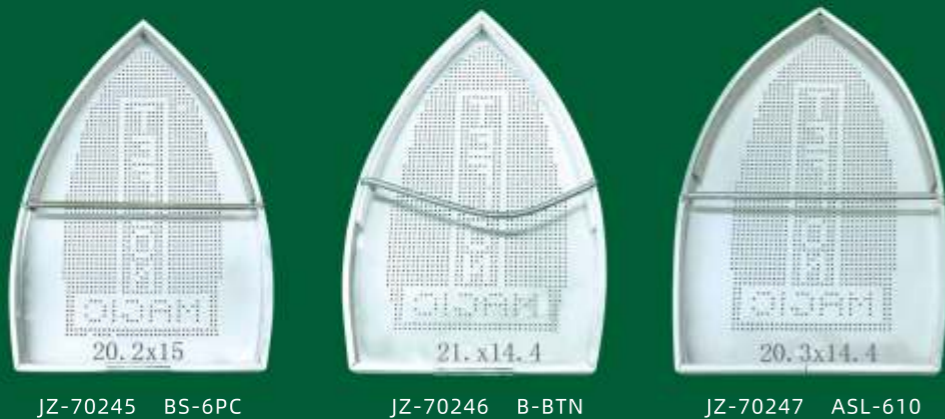

JZ-70245 BS-6PC JZ-70246 B-BTN JZ-70247 ASL-610

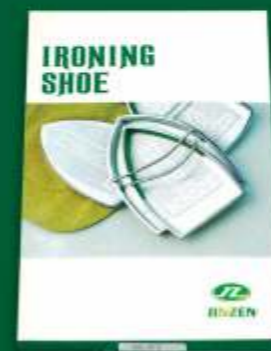

JZ-70263 小600 JZ-70264 300L (100) JZ-70265 STB-200 (BD1) JZ-70266 101



ES-85AF

JZ-70151

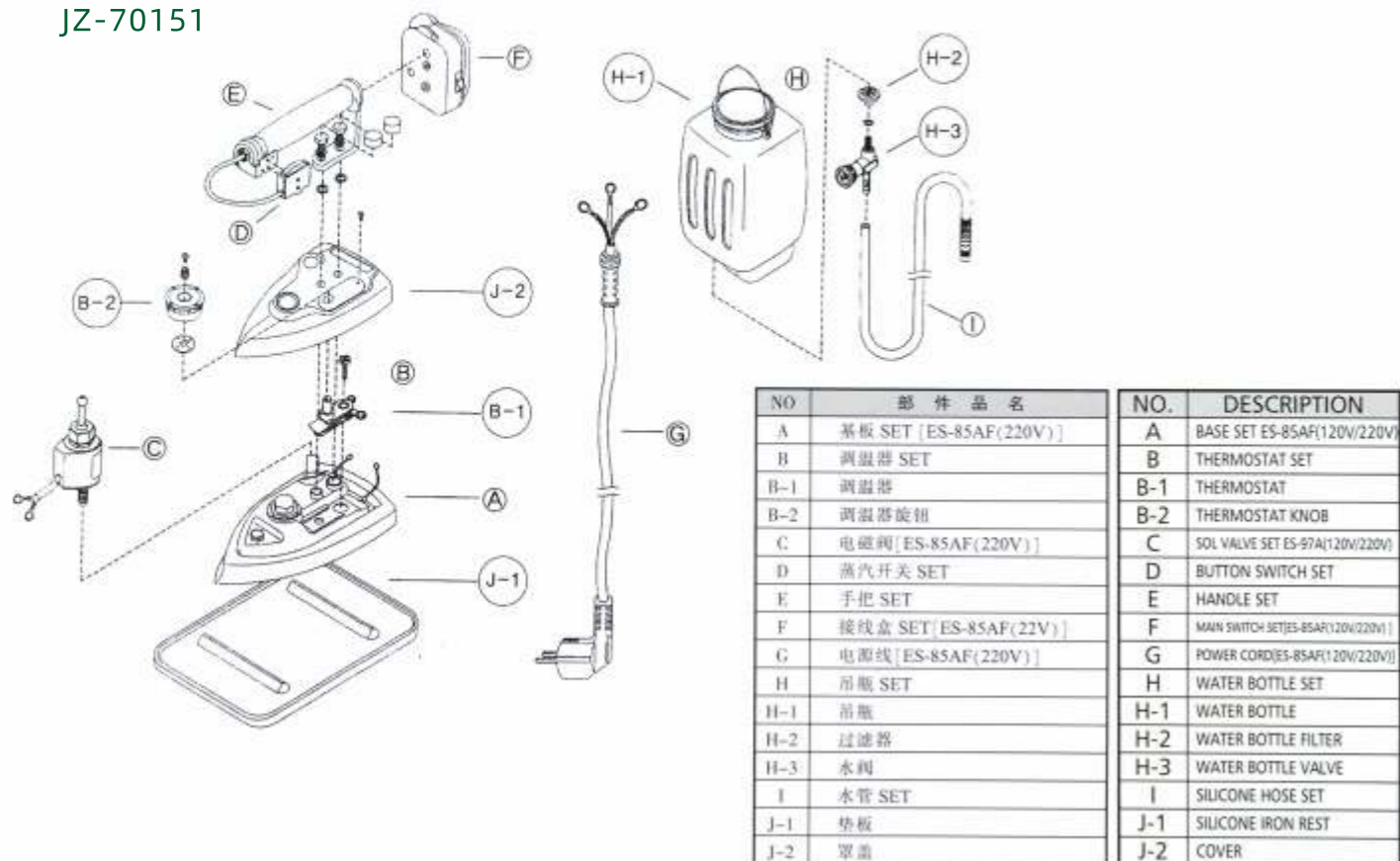

ES-94A/ES-94AL

JZ-70153

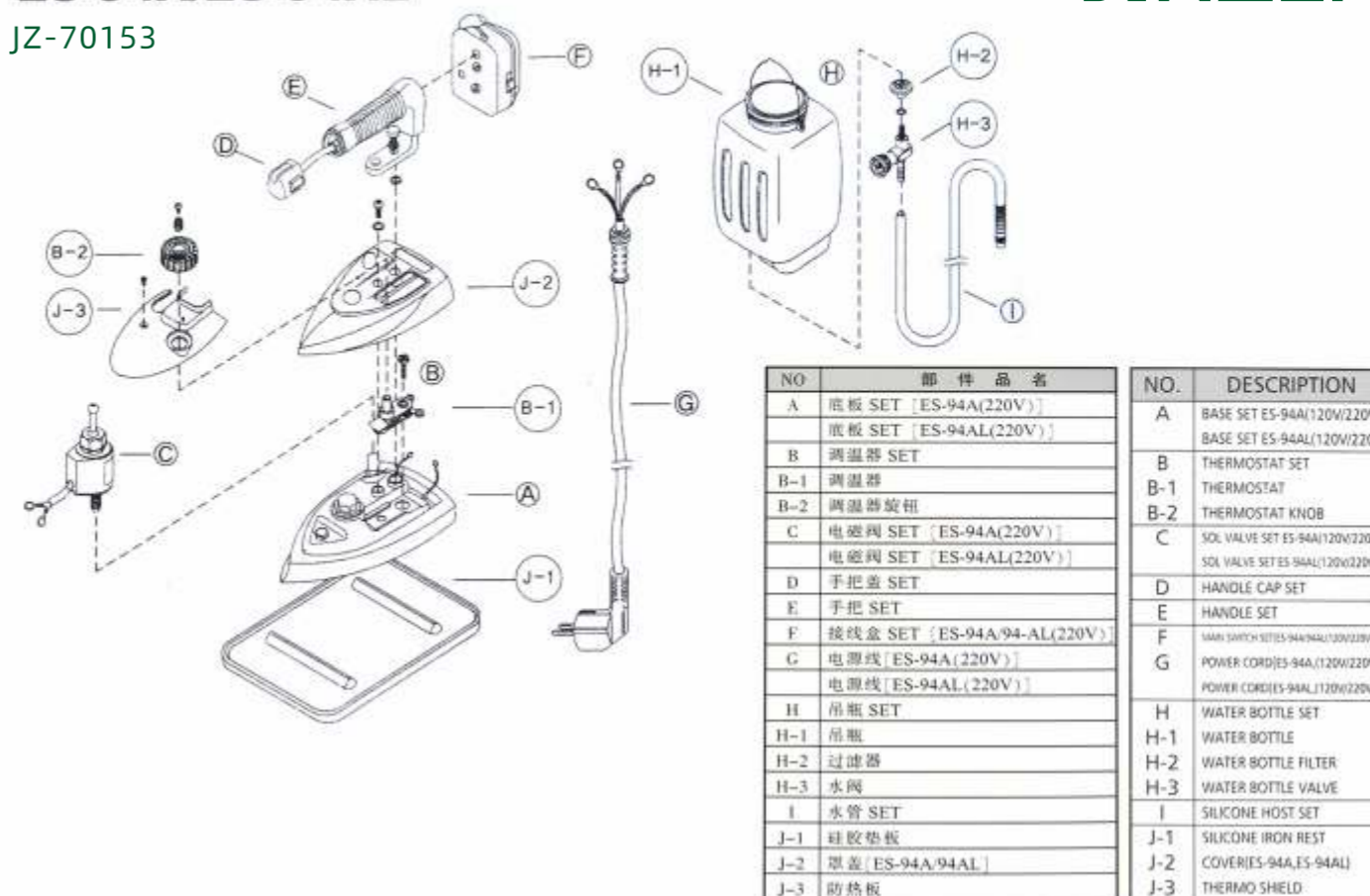

ES-90A

JZ-70152

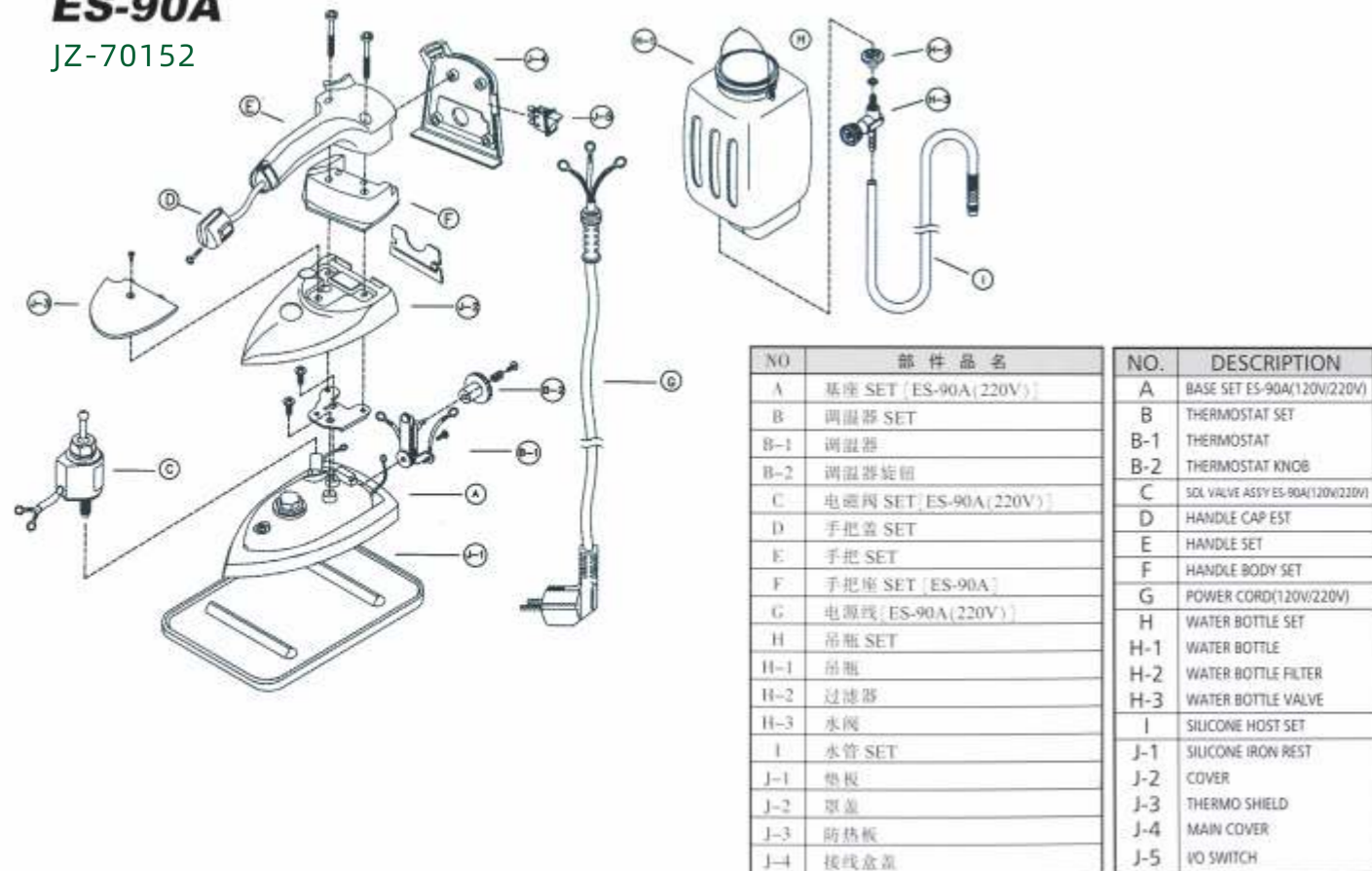

ES-97A

JZ-70154

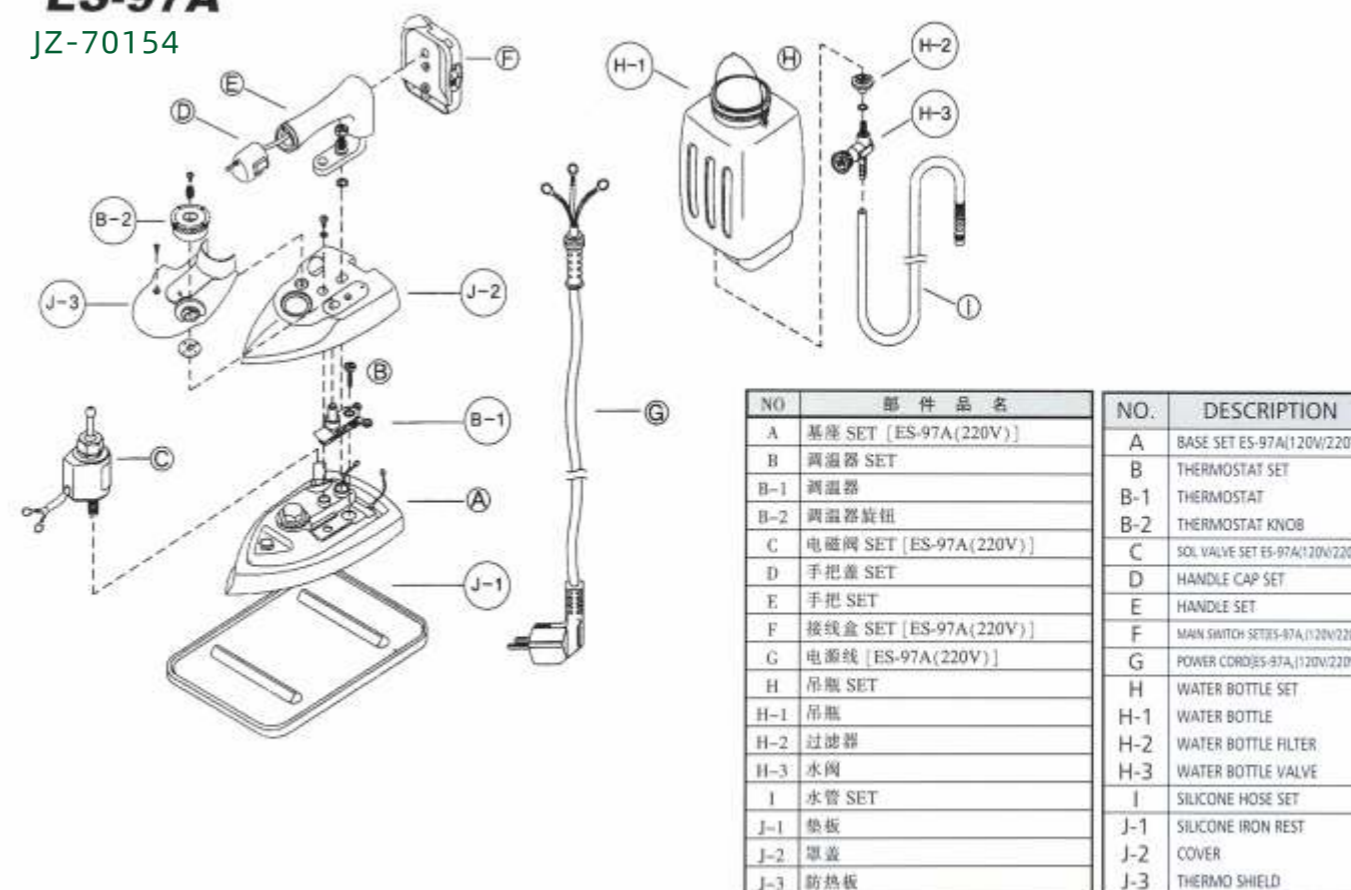

ES-300/ES-300L

JZ-70155

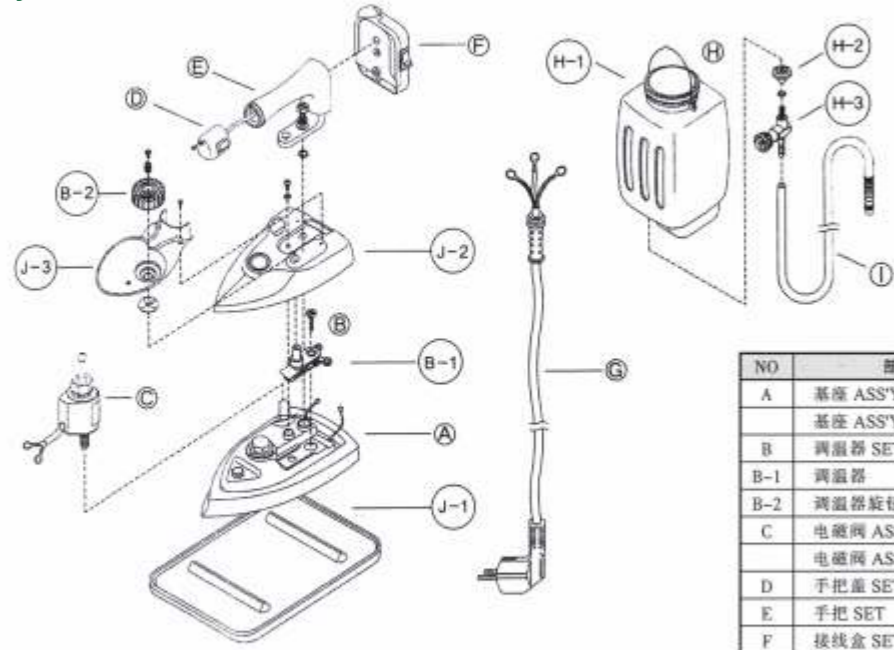

NO.	部 件 名 称	NO.	DESCRIPTION
A	底座 ASS'Y [ES-300(220V)]	A	BASE ASSY ES-300(120V/220V)
	底座 ASS'Y [ES-300L(220V)]		BASE ASSY ES-300L(120V/220V)
B	调温器 SET	B	THERMOSTAT SET
B-1	调温器	B-1	THERMOSTAT
B-2	调温器旋钮	B-2	THERMOSTAT KNOB
C	电磁阀 ASS'Y [ES-300(220V)]	C	SOL VALVE ASSY ES-300(120V/220V)
	电磁阀 ASS'Y [ES-300L(220V)]		SOL VALVE ASSY ES-300L(120V/220V)
D	手把盖 SET	D	HANDLE CAP SET
E	手把 SET	E	HANDLE SET
F	接线盒 SET [ES-300(220V)]	F	MAIN SWITCH SETES-300,(120V/220V)
	接线盒 SET [ES-300L(220V)]		MAIN SWITCH SETES-300L,(120V/220V)
G	电源线 [ES-300(220V)]	G	POWER CORD[ES-300,(120V/220V)]
	电源线 [ES300L,(220V)]		POWER CORD[ES-300L,(120V/220V)]
H	吊瓶 SET	H	WATER BOTTLE SET
H-1	吊瓶	H-1	WATER BOTTLE
H-2	过滤器	H-2	WATER BOTTLE FILTER
H-3	水阀	H-3	WATER BOTTLE VALVE
I	水管	I	SILICONE HOSE SET
J-1	铁板	J-1	SILICONE IRON SET ES-300/300L
J-2	罩盖 [ES-300/300L]	J-2	COVER[ES-300/300L]
J-3	防热板	J-3	THERMO SHIELD

ES-3200N II

JZ-70156

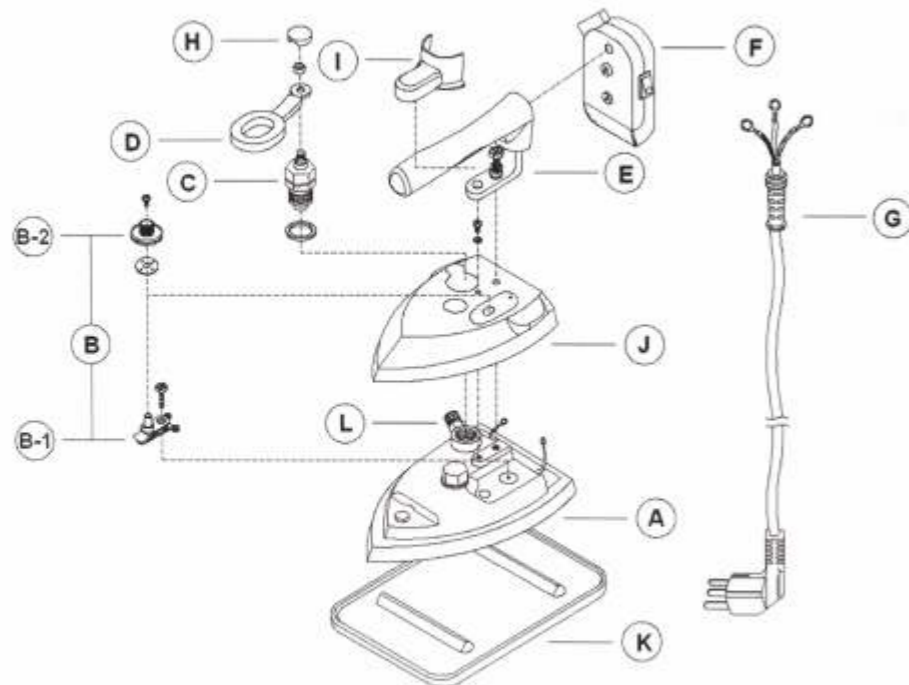

NO.	PARTS NAME
A	BASE SET[120V/220V]
B	THERMOSTAT SET
B-1	THERMOSTAT
B-2	THERMOSTAT KNOB
C	STEAM VALVE[SWING]
D	VALVE LEVER[SWING]
E	HANDLE SET
F	MAIN SWITCH SET
G	POWER CORD[120V/220V]
H	STEAM VALVE CAP
I	HANDLE BRACKET CAP
J	COVER
K	SILICONE IRON REST
L	NIPPLE[C/E TYPE]

SE-2000N

JZ-70157

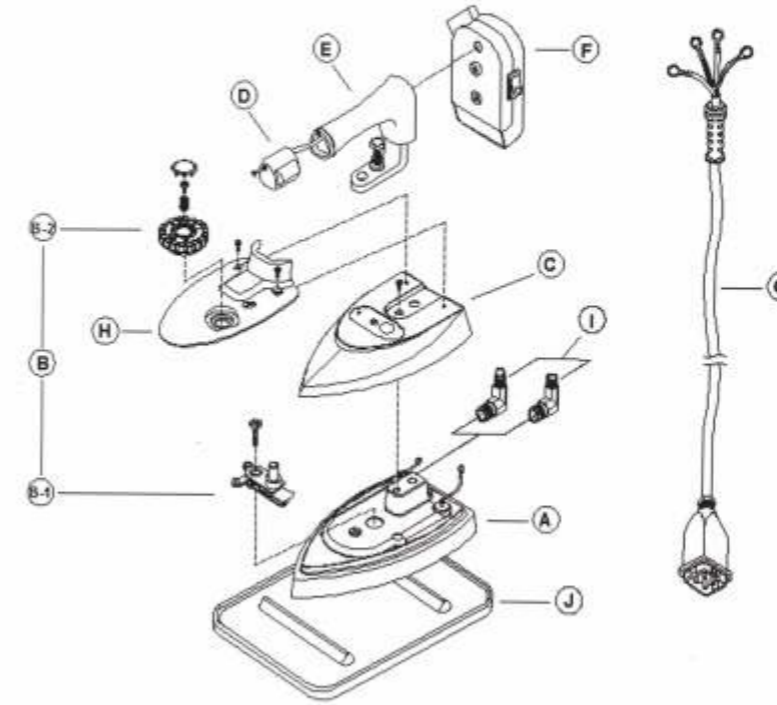

NO.	配件名称
A	底座套 [220V/1000W]
B	调温器套
B-1	调温器
B-2	调温器旋钮
C	罩盖
D	手把盖套
E	手把套
F	接线盒套
G	电源线套 [4芯]
H	防热板
I	管接头 [C/E 型]
J	铁板 [中]

BS-8SC

JZ-70170

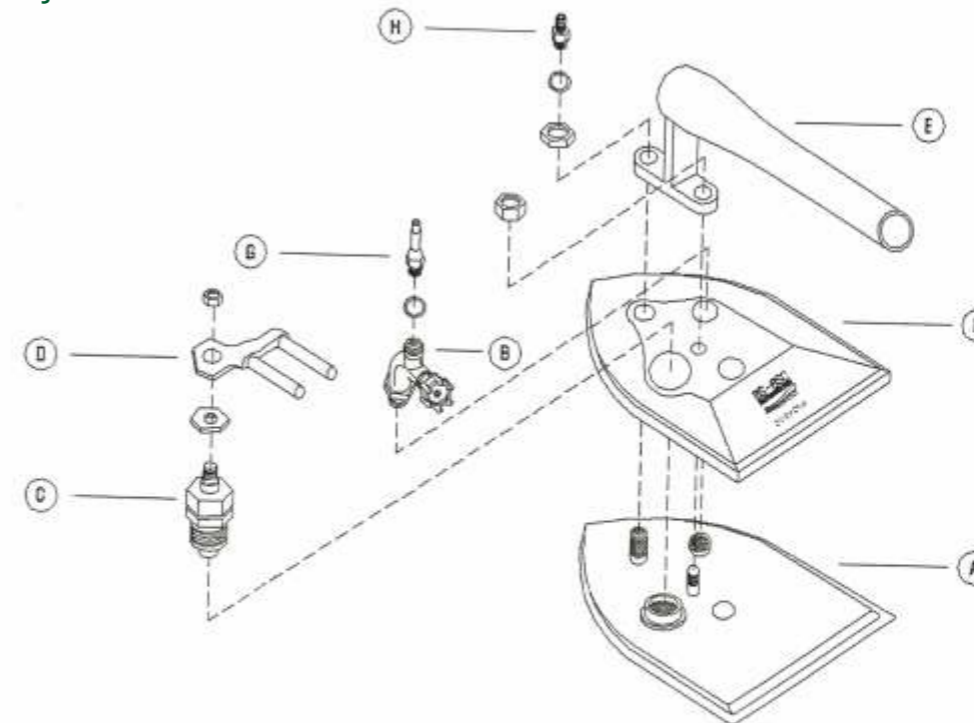

NO.	PARTS NAME
A	BASE[BS-8SC]
B	EXIT VALVE
C	STEAM VALVE[SWING TYPE]
D	VALVE LEVER[SWING TYPE]
E	HANDLE SET
F	COVER
G	NIPPLE[A]
H	NIPPLE[C]

BS-3PC JZ-70171

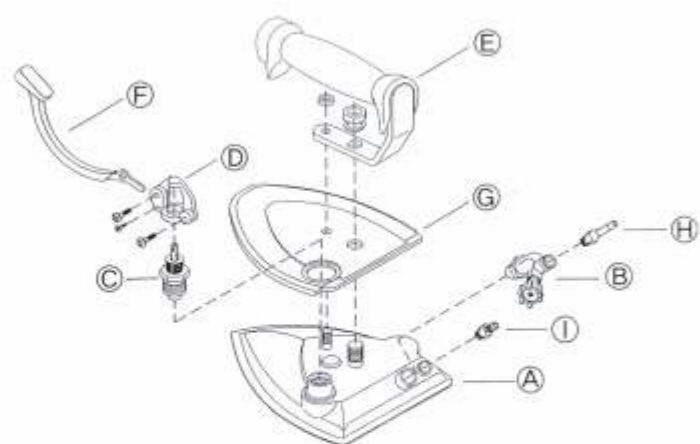

NO	部件品名	NO.	DESCRIPTION
A	底座	A	BASE
B	回汽阀	B	EXIT VALVE SET
C	气阀	C	STEAM VALVE SET
D	气阀架	D	VALVE BAND SET
E	手柄	E	HANDLE SET
F	气阀手柄	F	VALVE LEVER
G	罩盖	G	COVER
H	回气接头(E)	H	NIPPLE (A)
I	进汽接头	I	NIPPLE (C)

BSP-200 JZ-70174

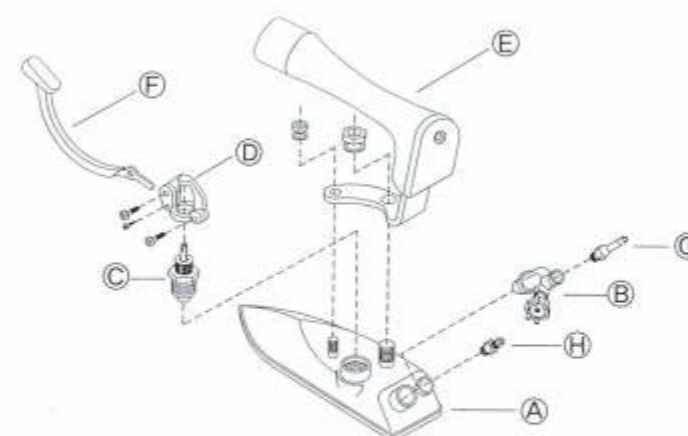

NO	部件品名	NO.	DESCRIPTION
A	底座	A	BASE
B	回汽阀	B	EXIT VALVE SET
C	气阀	C	STEAM VALVE SET
D	气阀架	D	VALVE BAND SET
E	手柄	E	HANDLE SET
F	气阀手柄	F	VALVE LEVER
G	回气接头(E)	G	NIPPLE (A)
H	进汽接头	H	NIPPLE (C)

BS-6PC JZ-70172

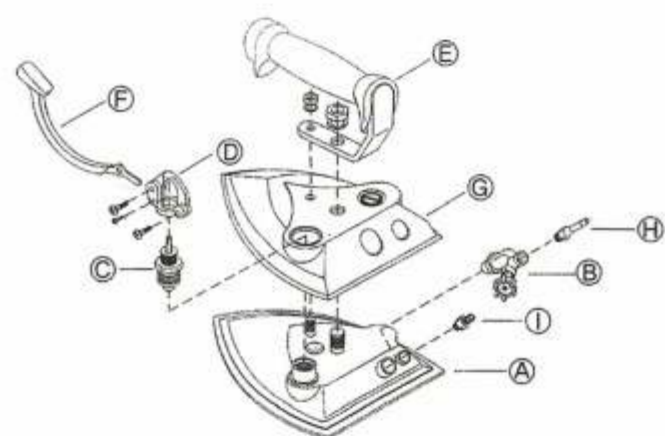

NO	部件品名	NO.	DESCRIPTION
A	底座	A	BASE
B	回汽阀	B	EXIT VALVE SET
C	气阀	C	STEAM VALVE SET
D	气阀架	D	VALVE BAND SET
E	手柄	E	HANDLE SET
F	气阀手柄	F	VALVE LEVER
G	罩盖	G	COVER
H	回气接头(E)	H	NIPPLE (A)
I	进汽接头	I	NIPPLE (C)

BSP-300 JZ-70175

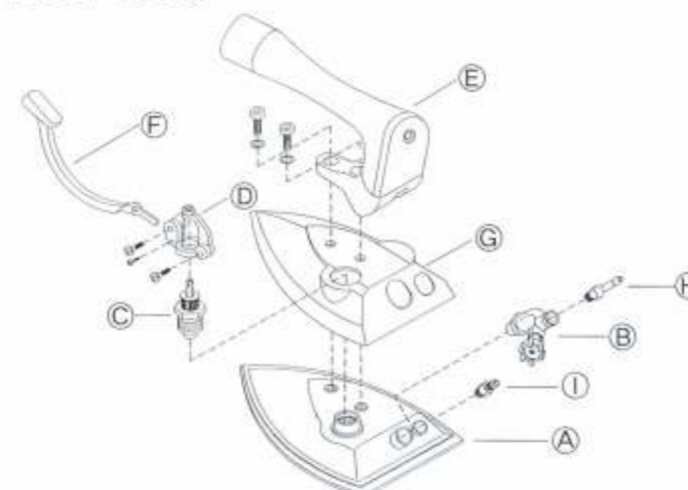

NO	部件品名	NO.	DESCRIPTION
A	底座	A	BASE
B	回汽阀	B	EXIT VALVE SET
C	气阀	C	STEAM VALVE SET
D	气阀架	D	VALVE BAND SET
E	手柄	E	HANDLE SET
F	气阀手柄	F	VALVE LEVER
G	罩盖	G	COVER
H	回气接头(E)	H	NIPPLE (A)
I	进汽接头	I	NIPPLE (C)

BSS-600 JZ-70173

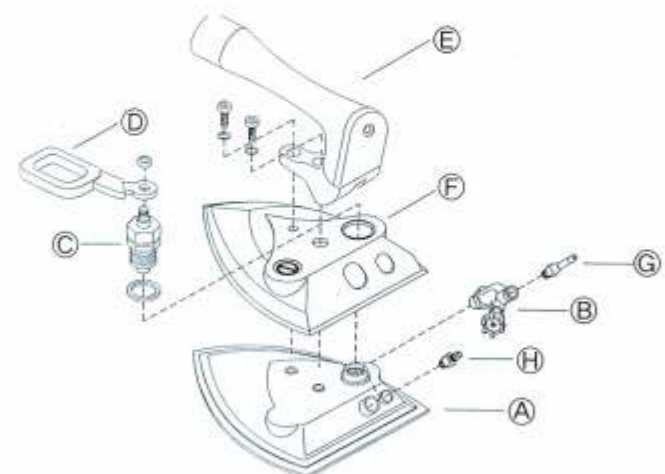

NO	部件品名	NO.	DESCRIPTION
A	底座	A	BASE
B	回汽阀	B	EXIT VALVE SET
C	气阀	C	STEAM VALVE SET
D	气阀手柄	D	VALVE LEVER
E	手柄	E	HANDLE SET
F	罩盖	F	COVER
G	回气接头(E)	G	NIPPLE (A)
H	进汽接头	H	NIPPLE (C)

BSP-600 JZ-70176

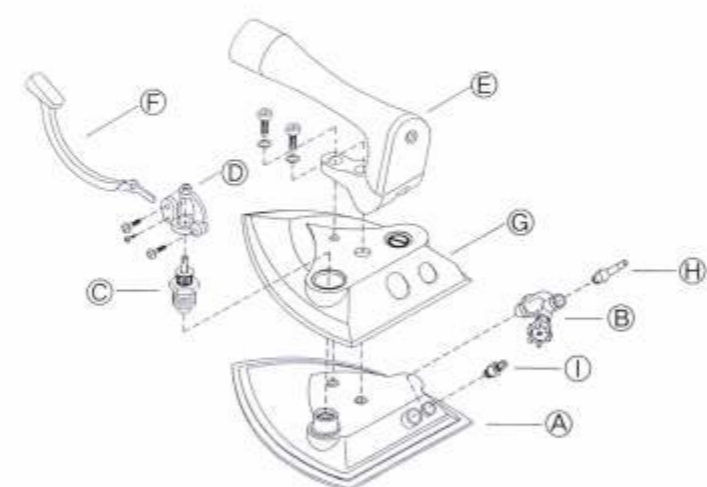

NO	部件品名	NO.	DESCRIPTION
A	底座	A	BASE
B	回汽阀	B	EXIT VALVE SET
C	气阀	C	STEAM VALVE SET
D	气阀架	D	VALVE BAND SET
E	手柄	E	HANDLE SET
F	气阀手柄	F	VALVE LEVER
G	罩盖	G	COVER
H	回气接头(E)	H	NIPPLE (A)
I	进汽接头	I	NIPPLE (C)

JINZEN®

衣车油漆 PAINT FOR SEWING MACHINE



色标 COLOR SAMPLE	编号 PARTS NO.	适用车型 SUITABLE MACHINE	油漆类别 PAINT STYLE
	JZ-70401	祖奇 平车 JUKI DDL-555	锤纹喷漆 HAMMER FINISH PAINT
	JZ-70402	祖奇 平车 JUKI DDL-5550	自动喷漆(平纹) IN/EX SPRAY PAINT
	JZ-70403	祖奇 双针车 JUKI LH-515	锤纹喷漆 HAMMER FINISH PAINT
	JZ-70404	兄弟 平车 BROTHER DB2-B735	锤纹喷漆 HAMMER FINISH PAINT
	JZ-70405	兄弟 平车 BROTHER DB2-B755	锤纹喷漆 HAMMER FINISH PAINT
	JZ-70406	雅满桃 多针环 缝车 YAMATO Vf2500	自动喷漆(平纹) IN/EX SPRAY PAINT
	JZ-70407	于仁 埋夹车 (旧款) UNION SPECIAL 35800(OLD)	锤纹喷漆 HAMMER FINISH PAINT
	JZ-70408	银箭 包缝车 SIRUBA 747	自动喷漆(平纹) IN/EX SPRAY PAINT
	JZ-70409	雅满桃 多针环 缝车 YAMATO DW-1500	锤纹喷漆 HAMMER FINISH PAINT
	JZ-70410	真善美 平车 JANOME 706	锤纹喷漆 HAMMER FINISH PAINT
	JZ-70411	于仁 埋夹车 (新款) UNION SPECIAL 35800(NEW)	自动喷漆(平纹) IN/EX SPRAY PAINT
	JZ-70412	利是 凤眼车 REECE 101	自动喷漆(平纹) IN/EX SPRAY PAINT

TAGGING GUN

* 全新设计，解决了以往吊牌枪固定齿轮掉牙和固定钩子易磨损，本枪使用不锈钢钩子和伸缩弹簧钩，在插入胶针时会自动退缩，拔出胶针时按箭头所示向后扳，再拔胶针，不会磨损钩子，延长使用时间。



JINZEN®

GUN NEEDLE



JZ-70601
202



S标准枪针(B)
S standard needle(B)

JZ-70602
S-38 刀针



S标准刀针
S standard needle

JZ-70603
203 细针



X细枪针
X fine needle

JZ-70604
204 长针



L长枪针
L long needle

JZ-70605
205 细长针



XL细长枪针
XL fine long needle

JZ-70606
203 刀针



标准刀枪针
Standard cut needle

JZ-70607
203 细刀针



细刀枪针
Fine cut needle

JZ-70608
106 塑料刀针



塑料柄标准刀枪针
Plastic head standard cut needle

JZ-70609



塑料柄长刀枪针
Plastic head long cut needle

JZ-70610
X-30 塑料细刀针



塑料柄细刀枪针
Plastic head fine cut needle

因为用心,所以专业
BECAUSE THE HEART, SO PROFESSIONAL
STANDARD PIN

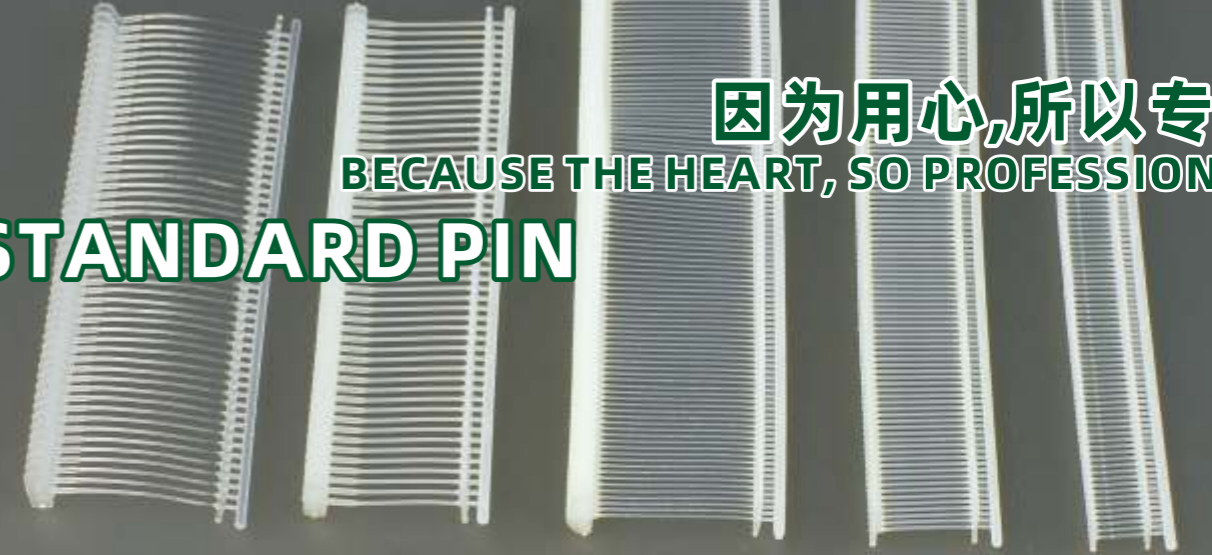

JZ-70651

5mm PP	25mm PP
7mm PP	35mm PP
8mm PP	50mm PP
9mm PP	65mm PP
10mm PP	75mm PP
12mm PP	100mm PP
15mm PP	125mm PP

JZ-70652

5mm NYLON	25mm NYLON
7mm NYLON	35mm NYLON
8mm NYLON	50mm NYLON
9mm NYLON	65mm NYLON
10mm NYLON	75mm NYLON
12mm NYLON	100mm NYLON
15mm NYLON	125mm NYLON



JZ-70653
问字钩 HOOK PIN

HP 35 PP
HP 50 PP
HP 65 PP



JZ-70654
圆字勾 RING PIN

RP 35 PP
RP 50 PP
RP 65 PP



JZ-70655
双排钉 DOUBLE PINS

DP 35 PP
DP 50 PP
DP 65 PP
DP 75 PP



JZ-70656
吊环 LOOP PINS

LP- 3 inch
LP- 5 inch
LP- 7 inch
LP- 9 inch
LP-12inch
LP-16inch
LP-18inch



JZ-70657
吊环 LOOP PINS

LP- 3 inch
LP- 5 inch
LP- 7 inch
LP- 9 inch



JZ-70658
吊环 LOOP PINS

LP- 3 inch
LP- 5 inch
LP- 7 inch
LP- 9 inch



JZ-70659
吊环 LOOP PINS

LP- 3 inch
LP- 5 inch
LP- 7 inch
LP- 9 inch

JZ-70721-AAAAA 8" 9" 10" 11" 12"



JINZEN®

我们要做同行中的领跑者，创造美好品质、赋予贴心服务。

我们时刻要以严谨，高效，负责任的工作态度来要求自己，

使金振系列产品多元化，品质国际化，满意全球市场，更好的服务全球每一个客户。

We do the leader in the line, create a better quality,

and gives intimate service. We are always in strict,

efficient and responsible work attitude to demands on ourselves,

so that JINZEN products will be diversification, quality-internationalization,

satisfaction with the global market and better to serve every customer in the world.



JZ-70721-AAA

8" 9" 10" 11" 12"



JZ-70730-AAA

8" 9" 10" 11" 12"

JINZEN®



JZ-70731

JZ-70714



JZ-70700

JZ-70701

JZ-70702

JZ-70691
不锈钢 STEEL

JZ-70704

JZ-70705

JZ-70706

JZ-70707

JZ-70708

台湾品质
Taiwan quality

JZ-70713

台湾品质
Taiwan quality

JZ-70712

JZ-70696

JZ-70694

JZ-70698

JZ-70693

JZ-70692

JZ-70692-A

JZ-70699
不锈钢 STEEL



JZ-70738 A3

JZ-70739-AAAAAJP202

JZ-70740AAA P01

JZ-70741
电加热



JZ-70720 1#



JZ-70720 2#



JZ-70720 3#



JZ-70725



JZ-70716



JZ-70722



JZ-70723



JZ-70742 平头



JZ-70743 平头



JZ-70744



JZ-70733
不锈钢 STEEL



JZ-70728



JZ-70727



JZ-70729



JZ-70734



JZ-70715 9"
不锈钢 STEEL



JZ-70715 10"
不锈钢 STEEL



JZ-70735
不锈钢 STEEL



JZ-70736
不锈钢 STEEL



JZ-70737
不锈钢 STEEL

卓越品质 源自台湾

EXCELLENT QUALITY ORIGINAL TAIWAN

通过CE认证
Lights have obtained
CE certificate.

JINZEN



JZ-70831

JZ-70830

NEW FEATURES

- ◎ Built-in reflection film to increase brightness.
- ◎ Acrylic cover to protect LED from dust/oil.
- ◎ Good quality PCB, and with small holes at the back of the lamp head, easy heat radiating.
- ◎ "G" clamp can be 4CM maximum.

產品特性

- ◎ 燈頭裏面使用納米反光膜,使亮度更好!
- ◎ 燈頭採用亞克力燈罩,防塵防油設計,可避免油對燈珠的腐蝕損壞,外觀大氣。
- ◎ 燈頭後面有四個小型出氣孔,且採用了鋁合金燈板,可防止燈珠過熱而造成的亮度衰減。
- ◎ 加厚的G型夾,張開距離為4CM。

可選擇聯線方式(Optional connection)



CHINESE CCC PLUGS
中國CCC標準插頭

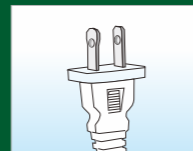

UL/CSA (C-UL) PLUGS
美國/加拿大標準插頭



GERMANY VDE PLUGS
德國VDE標準插頭



Motor Switch
馬達開關聯接

磁吸系列 Magnetic Series

方便快捷, 高效率
Convenient,
high efficiency



JZ-70849



JZ-70832



JZ-70833



JZ-70834



JZ-70815



JZ-70815A



JZ-70829



(Brightness can be daylight or purple)
白光/紫光可切换
Applicable to leather machinery
箱包皮鞋厂专用



JZ-70850 可调光DIMMABLE

JZ-70805

JZ-70837

JZ-70839

JZ-70838 可调光DIMMABLE



JINZEN LED工作灯 SEWING MACHINE LED LIGHT,

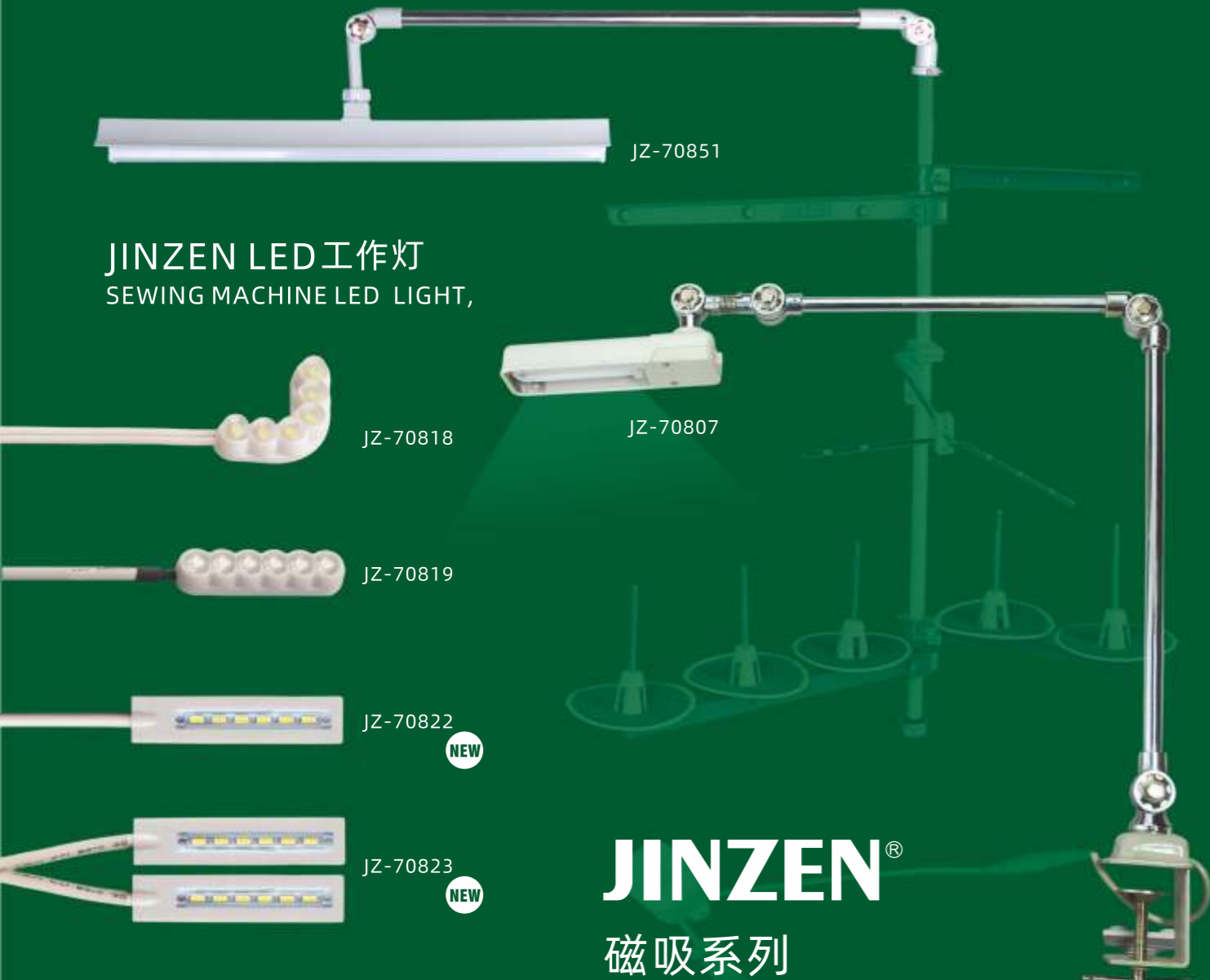

JINZEN® 磁吸系列 Magnetic Series

可選擇聯線方式(Optional connection)



DC3 5 Terminal
DC3 5端子 (3V)

EL Terminal
EL 端子 (3V)

Motor Switch
馬達開關連接

方便快捷，高效率
Convenient,
high efficiency

LED數量/LED Amount	2Pcs/6Pcs/10Pcs/12Pcs
功率/Power	0.5W/1W/5W
頻率/Frequency	50HZ/60HZ
輸出電流(DC) / Output current (DC)	120mA/60mA /40mA
色溫/Color temperature	6000-6500K
壽命/Lifespan	50000H
工作環境溫度/Environment temperature	-40+50℃
額定電壓/Rated Voltage	AC110-250V/ AC380V
固定方式/Fixed mode	高性能磁鐵 Magnet / 螺絲固定Screw
接線/Link	馬達開關 Motor Switch / 電控箱 Electric Cabinet 可選擇聯線方式 Optional connection



卓越品质 源自台湾
EXCELLENT QUALITY ORIGINAL TAIWAN





验布器 CLOTH INSPECTOR

JZ-70900



JZ-70900



JZ-70901



JZ-70904



JZ-70902



可调解



JZ-70903



JZ-70913



JZ-70914

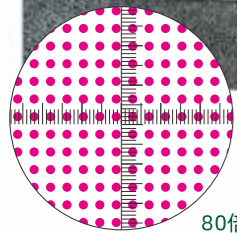

80倍

激光定位器 (Laser Light Positioner)



JZ-70915
(点状)/(Point)



JZ-70916
(直线)/(Line)



JZ-70917
(十字)/(Cross)

激光标线器 (镭射标线器)

激光标线器可广泛用于各种裁床机制布定位、放线。
能产生一字和十字清晰明亮的红线、体积小、方便调节、易于安装、
稳定可靠。能较大幅度的提高工作效率。
我们还可以提供电源内置一体式镭射标线器，使客户的使用更加方便。

The equipment is wide applies to various cloth localization cutting machine,
collimated package machine. It can emit a clear bright red line like one and ten,
and has small body with easy adjustd. It is also easy to set up and also safe stability.
It can improve working efficiency highly. we can offer a unity series laser
marking-off equipment with power supply inside for easier using.



JZ-70905 360度 DEGREES



JZ-70906 RED
(点状)/(Point)



JZ-70907 RED
(直线)/(Line)



JZ-70908 RED
(十字)/(Cross)



激光标线器 (镭射标线器)



JZ-70911 GREEN
(直线)/(Line)

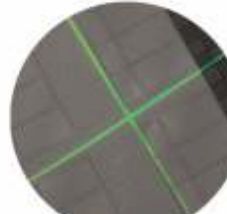

JZ-70912 GREEN
(十字)/(Cross)

JINZEN®



JZ-70920 JZ-70921 JZ-70922 JZ-70923



Multifunctional Toolkit 多功能工具包



JZ-70924 JZ-70925 JZ-70926 JZ-70927



JZ-70918

◆ 高温消色笔



JZ-70971
JZ-70972
JZ-70973
JZ-70974
JZ-70975

◆ 皮革水银笔



JZ-70976
JZ-70977
JZ-70978
JZ-70979
JZ-70980
JZ-70981
JZ-70982

◆ 高温消色笔 (细)



JZ-70983
JZ-70984
JZ-70985
JZ-70986
JZ-70987



JZ-70988
JZ-70989



JZ-70990
JZ-70991



JZ-70992
JZ-70993

◆ 无痕皮革高温消失笔

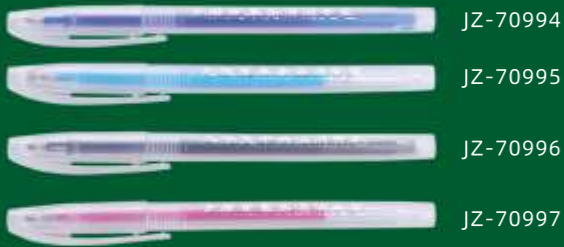

JZ-70994
JZ-70995
JZ-70996
JZ-70997

◆ 水银清洗笔



JZ-70998
JZ-70999

大容量水银笔



JZ-71000
JZ-71002
JZ-71003
JZ-71004
JZ-71005
JZ-71006
JZ-71007

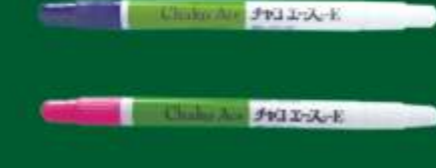

JZ-71008
JZ-71009



JZ-71010
JZ-71011



JZ-71012
JZ-71013



JZ-71014
JZ-71015



JZ-71016



JZ-71020
JZ-71021



JZ-71019
JZ-70970



JZ-71100 TWE 7
JZ-71101 TWE 8
JZ-71102 TWE 6
JZ-71022 with teeth
JZ-71023
JZ-71024
JZ-71107
JZ-71108



JZ-71037
JZ-71038
JZ-71098
JZ-71039
JZ-71040
JZ-71099
JZ-71025
JZ-71026



JZ-71035
JZ-71027
JZ-71028
JZ-71029
JZ-71032
JZ-71033
JZ-71034



JZ-71030A
JZ-71030B
JZ-71030E
JZ-71030
JZ-71031

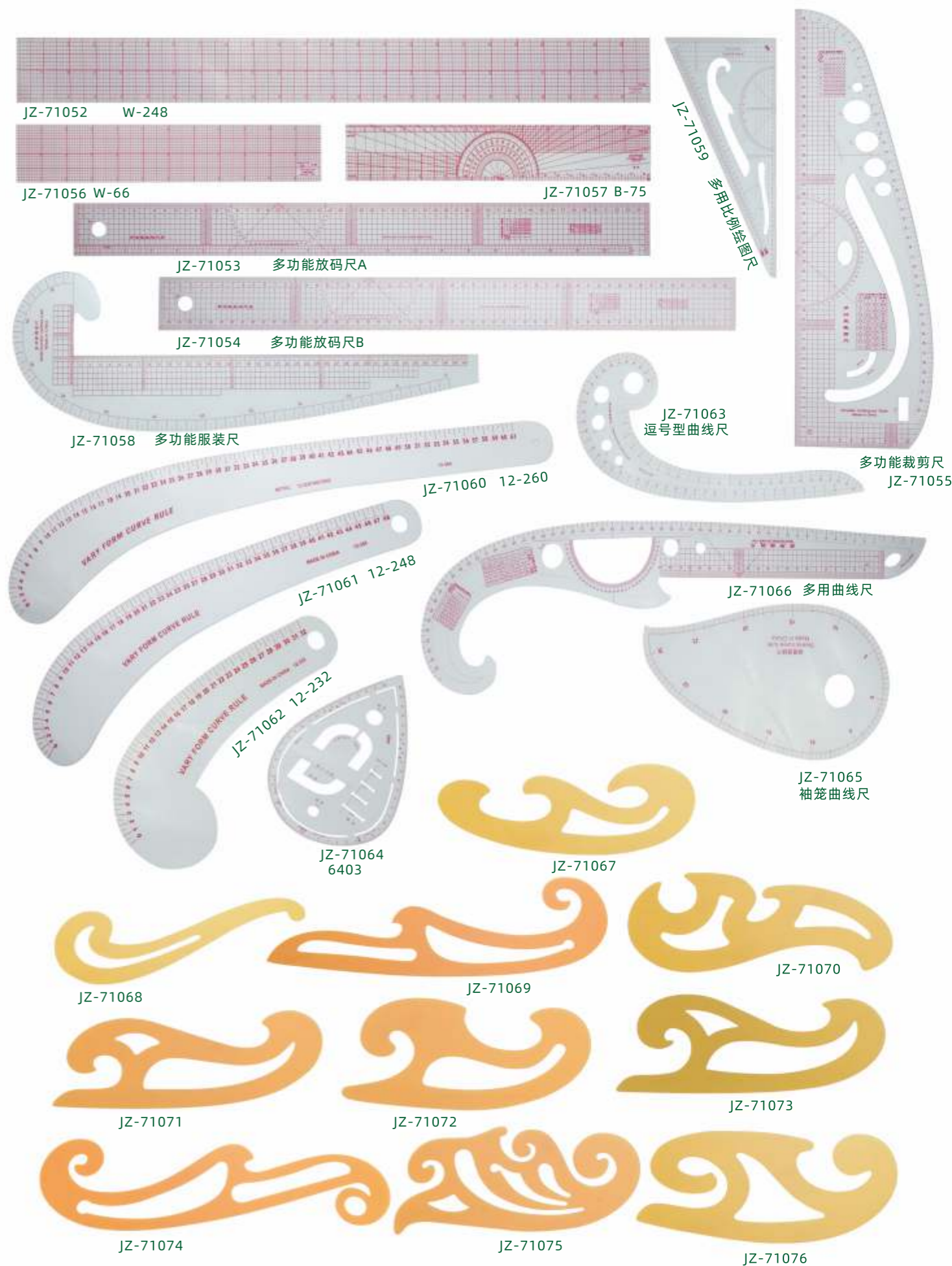



JZ-71201



JZ-71202



JZ-71207



JZ-71203



JZ-71204



JZ-71205



JZ-71206



JZ-71353



JZ-71352



JZ-71208



JZ-71301



JZ-71302



JZ-71303



JZ-71304



JZ-71312



JZ-71209

JZ-71210



JZ-71305

JZ-71307

JZ-71308



JZ-71350



JZ-71351



JZ-71309



JZ-71310



JZ-71311



JZ-71313

卓越新品

金振精工螺丝刀采用优质钢材，硬度高，不易折。
金振精工螺丝刀您的信赖之选。



JZ-71333 JZ-71334 JZ-71335 JZ-71336 JZ-71337 JZ-71338

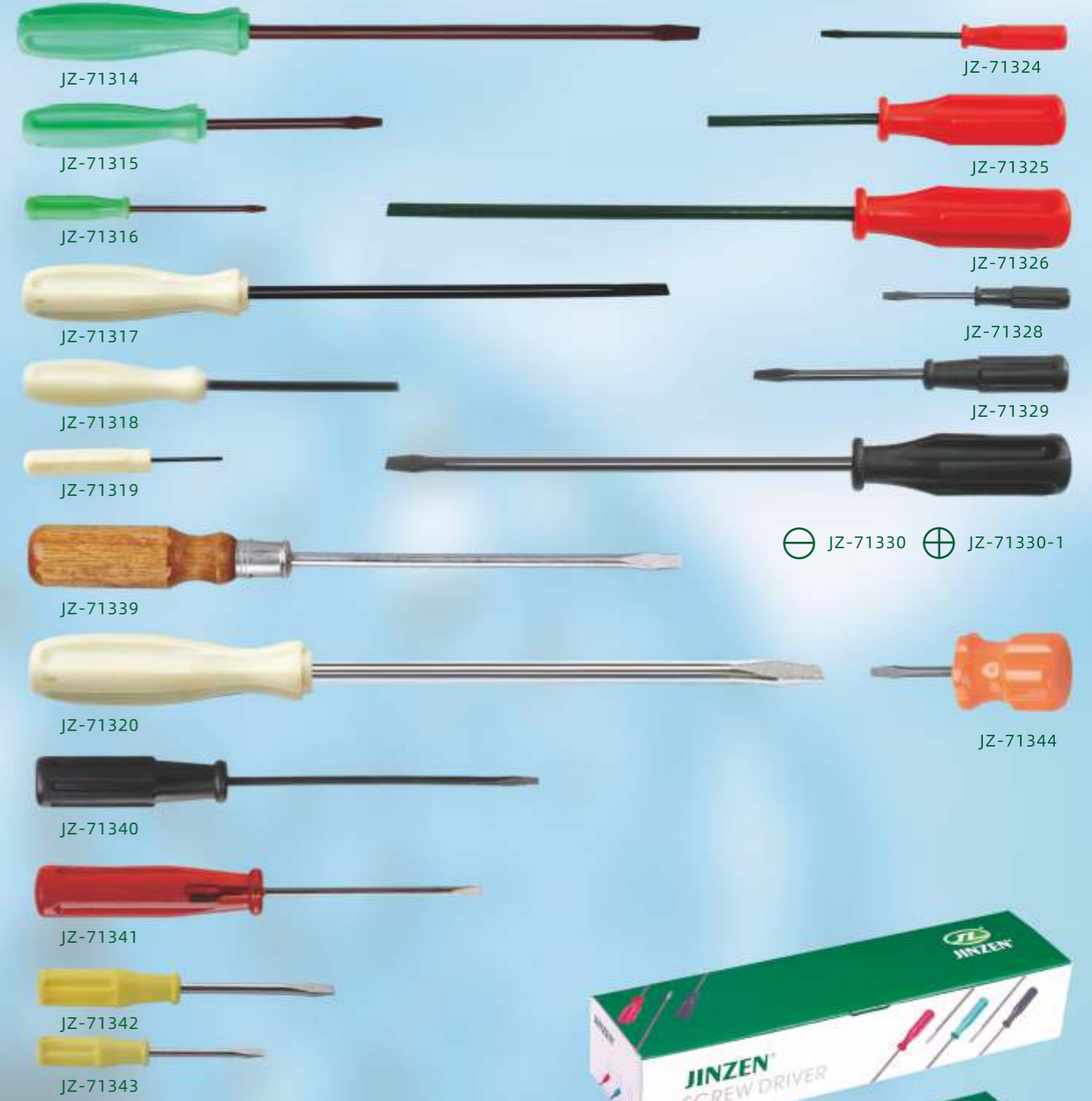

JZ-71314 JZ-71315 JZ-71316 JZ-71317 JZ-71318 JZ-71319 JZ-71339 JZ-71320 JZ-71340 JZ-71341 JZ-71342 JZ-71343 JZ-71324 JZ-71325 JZ-71326 JZ-71328 JZ-71329 JZ-71330 JZ-71330-1 JZ-71344





JZ-71401 JZ-71402 JZ-71403 JZ-71404 JZ-71405 JZ-71406 JZ-71423



JZ-71407 JZ-71408 JZ-71409 JZ-71410 JZ-71411 JZ-71412



JZ-71413 JZ-71414 JZ-71415 JZ-71416 JZ-71417



JZ-71418 JZ-71419 JZ-71420 M18-M65 JZ-71421 JZ-71424 4/6/8mm



JZ-71422

ANY SIZE CAN BE CUSTOMIZED 任何尺寸都可定制



JZ-71450 JZ-71451 JZ-71452 JZ-71453 JZ-71449 JZ-71454 JZ-71455



JZ-71456 JZ-71457 JZ-71458 JZ-71459 JZ-71460 JZ-71461



JZ-71462 JZ-71463 JZ-71464 JZ-71465 JZ-71466 JZ-71467 JZ-71468



JZ-71469 JZ-71470 JZ-71471 JZ-71472 JZ-71473 JZ-71474



JZ-71475 CL12 JZ-71476 CL3 JZ-71477 CL3L JZ-71478 CL1L JZ-71479 CL1G JZ-71480 CL1 JZ-71481 CL2



JZ-71482 CL70 JZ-71483 4" 6" 8" 10" JZ-71484 4" 6" 8" 10" JZ-71485 4" 6" 8" 10" 不锈钢STEEL JZ-71486 4" 6" 8" 10" 不锈钢STEEL JZ-71487 CL5



JZ-71492 JZ-71490 JZ-71488 JZ-71489 JZ-71491



内六角紧定螺钉
JZ-71501



球面圆柱头复合槽螺钉
JZ-71502



六角轴位螺钉
JZ-71503

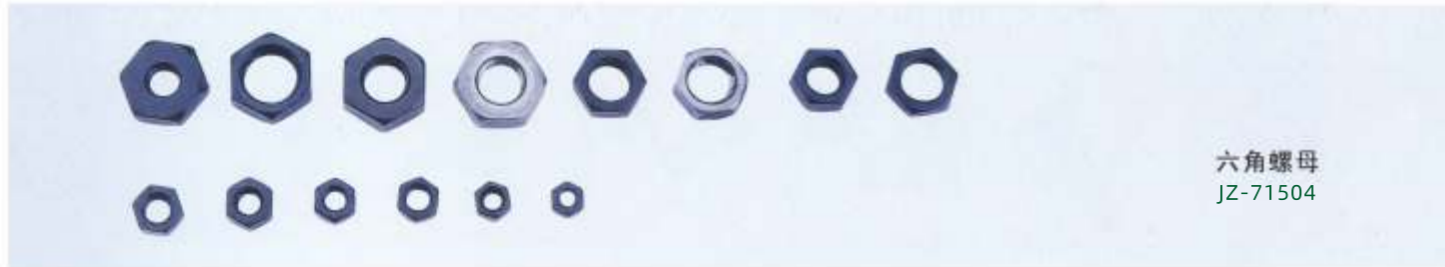

六角螺母
JZ-71504



一字槽沉头螺钉
JZ-71505



圆柱头螺钉
JZ-71506



球面圆柱头螺钉
JZ-71507



圆柱头内六角螺钉
JZ-71508



圆柱头滚花
内六角螺钉
JZ-71509



开槽凹端紧定螺钉
JZ-71510



JZ-71511



JZ-71512



JZ-71513



JZ-71514



JZ-71515



JZ-71516





JZ-71701



JZ-71702



JZ-71703



JZ-71719



JZ-71720



JZ-71721



JZ-71704



JZ-71705



JZ-71706



JZ-71722



JZ-71723



JZ-71724



JZ-71707



JZ-71708



JZ-71709



JZ-71725



JZ-71726



JZ-71727



JZ-71710



JZ-71711



JZ-71712



JZ-71728 E52四线侧罩



JZ-71729 E32五线侧罩



JZ-71730 747D侧罩



JZ-71713



JZ-71714



JZ-71715



JZ-71732 海菱皮带罩20518



JZ-71733



JZ-71731



JZ-71716



JZ-71717



JZ-71718



JZ-71735 电动机皮带罩(不可调)



JZ-71736



JZ-71734 2516垃圾槽



JZ-71737 522垃圾槽



JZ-71801



JZ-71802



JZ-71803



JZ-71816



JZ-71817



JZ-71818



JZ-71804



JZ-71805



JZ-71806



JZ-71819



JZ-71820



JZ-71821



JZ-71807



JZ-71808



JZ-71809



JZ-71822



JZ-71823

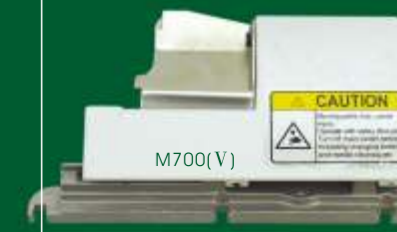

JZ-71824



JZ-71810



JZ-71811



JZ-71812



JZ-71825



JZ-71826

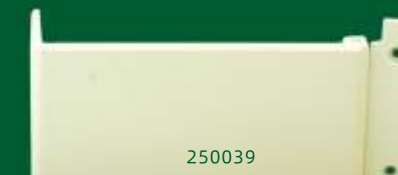

JZ-71827



JZ-71813



JZ-71814



JZ-71815



JZ-71828



JZ-71829



JZ-71830



JZ-71901



JZ-71902



JZ-71903



JZ-71904



JZ-71905



JZ-71906



JZ-71907



JZ-71908



JZ-71909



JZ-71910



JZ-71911



JZ-71912



JZ-71913



JZ-71914



JZ-71915



JZ-71916



JZ-71917



JZ-71918



JZ-71919



JZ-71920



JZ-71921



JZ-71922



JZ-71923



JZ-71924



JZ-71925



JZ-71926



JZ-71938



JZ-71940



JZ-71941



JZ-71942



JZ-71927



JZ-71928



JZ-71929



JZ-71930



JZ-71936



JZ-71937



JZ-71943



JZ-71944



JZ-71945



JZ-71931



JZ-71932



JZ-71933



JZ-71934



JZ-71939



JZ-71946



JZ-71947



JZ-71948



JZ-72101 842



JZ-72105 845



JZ-72106 3168



JZ-72110 555



JZ-72114 GC6-5



JZ-72118 SUNSTAR



JZ-72122 652



JZ-72127 2153



JZ-72102 335



JZ-72107 335



JZ-72111 591



JZ-72115 735



JZ-72119 7200



JZ-72123 1850



JZ-72128 781W



JZ-72103 8810



JZ-72108 820



JZ-72112 GC6-1



JZ-72116 735



JZ-72120 9900



JZ-72124 781



JZ-72129 1900B



JZ-72104 0302



JZ-72109 8810



JZ-72113 5550



JZ-72117 1903



JZ-72121 1900A



JZ-72125 20U



JZ-72126 家用多功能



JZ-72130 家用多功能



JZ-72201 W500



JZ-72202 BR 735



JZ-72203 F007



JZ-72204 M700



JZ-72205 YAMATO



JZ-72206 555



JZ-72207 GC6-1



JZ-72208 M600



JZ-72209 MO3600



JZ-72210 8700



JZ-72211 M600



JZ-72212 MO3300



JZ-72213 747



JZ-72214 551



JZ-72215 1404



JZ-72216 MO3600



JZ-72217 2516



JZ-72218 R53



JZ-72219 GK31010



JZ-72220 MO2516



JZ-72221



JZ-72222



JZ-72223



JZ-72224



JZ-72225



JZ-72226



JZ-72227



JZ-72228



JZ-72229 GC28-3



JZ-72230 BR735



JZ-72231 BR101



JZ-72232 555



JZ-72233 GC1-9



JZ-72235



JZ-72236 SINGER191



JZ-72237 GC28-1



JZ-72238 JUKI 老款



JZ-72239 SINGER591

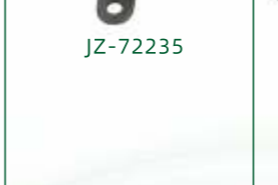

JZ-72240 GC6-1



JUKI 271/391

JZ-72301



GC6-5

JZ-72302



8810

JZ-72313



W600

JZ-72314



EX3200

JZ-72315



810

JZ-72303



M700

JZ-72304



JUKI 373

JZ-72316



747

JZ-72317

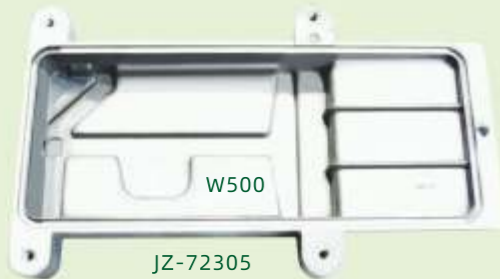

W500

JZ-72305



MO3300

JZ-72306



2516

JZ-72318



MO2516

JZ-72319

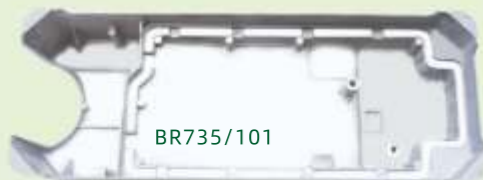

BR735/101

JZ-72307



GC6-1

JZ-72308

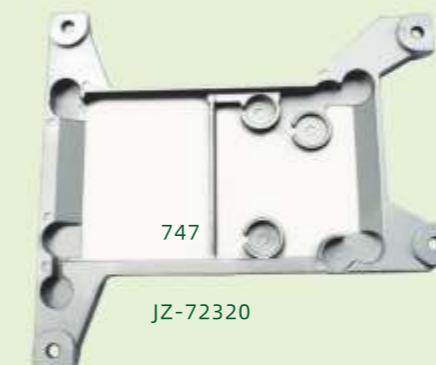

747

JZ-72320

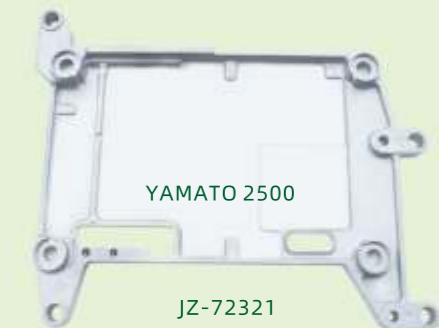

YAMATO 2500

JZ-72321



JUKI 5550

JZ-72309



JUKI3168

JZ-72310

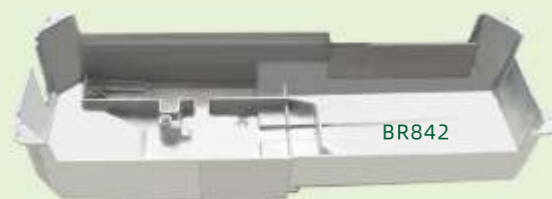

BR842

JZ-72311



380

JZ-72312



781

JZ-72322



JUKI 1850

JZ-72323



JZ-72396 多功能橡筋架

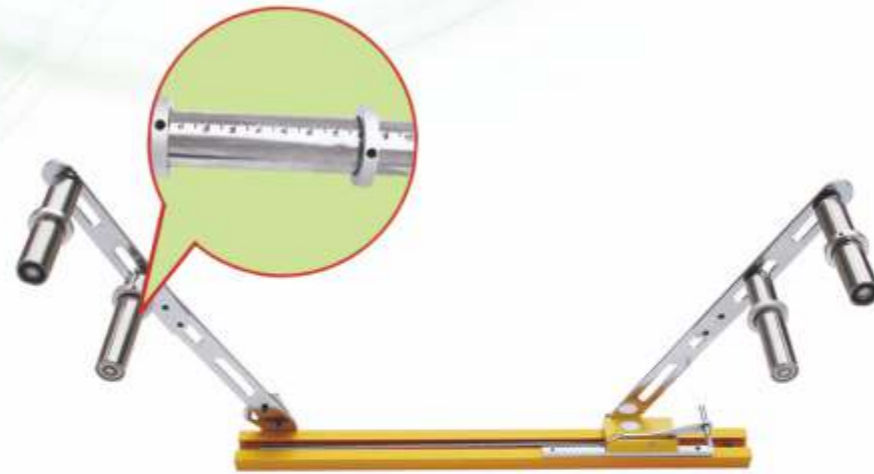

JZ-72402 特殊铝质(加大码)
活动啤唛架(橡筋架)
专用于: 橡筋车
裤头车



JZ-72397 扩展架 A



JZ-72403 固定啤唛架(橡筋架)
专用于: 橡筋车
裤头车



JZ-72398 扩展架 B



JZ-72404 特殊铝质
活动啤唛架(橡筋架)
专用于: 橡筋车
裤头车



JZ-72399 PDF(B)小嘴包缝机固定小滚轮



JZ-72400 筒式绷缝机滑轮器
PULLEY FOR CYLINDER TYPE
INTERLOCK SEWING MACHINE



JZ-72405 拉布机
适用于: 雨伞、牛仔等滑、厚料



JZ-72406



JZ-72407



JZ-72408



JZ-72409



JZ-72410



JZ-72411



JZ-72412



JZ-72413



JZ-72414



JZ-72415



JZ-72416



JZ-72417



JZ-72418



JZ-72419



JZ-72420



JZ-72421



JZ-72422



JZ-72448



JZ-72424



JZ-72425



JZ-72426



JZ-72427



JZ-72428



JZ-72429



JZ-72430

AL(铝)

45mm	80mm
50mm	85mm
55mm	90mm
60mm	95mm
65mm	100mm
70mm	110mm
75mm	120mm



JZ-72449

锥形孔

45mm	80mm
50mm	85mm
55mm	90mm
60mm	95mm
65mm	100mm
70mm	110mm
75mm	120mm



JZ-72432

8uf	24uf
10uf	25uf
12uf	28uf
14uf	30uf
16uf	38uf
18uf	50uf
20uf	70uf



JZ-72433

8uf	24uf
10uf	25uf
12uf	28uf
14uf	30uf
16uf	38uf
18uf	50uf
20uf	70uf



JZ-72434



JZ-72436



JZ-72435



JZ-72438

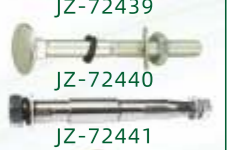

JZ-72439



JZ-72440



JZ-72441



JZ-72442

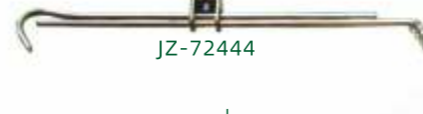

JZ-72444



JZ-72443

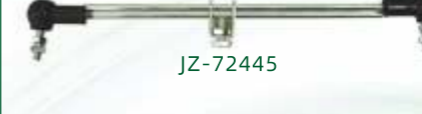

JZ-72445



JZ-72446

JZ-72447



JZ-72501
T2 228776



JZ-72502
T3 228777



JZ-72506
T3 228777



JZ-72503

Thread Stand	F2	F3	F4	F5	F6	F8	F12
--------------	----	----	----	----	----	----	-----



JZ-72504



JZ-72505



JZ-72522



JZ-72523



JZ-72521



JZ-72528



JZ-72524



JZ-72525



JZ-72526



JZ-72527 衣料斗



专业专注，全心服务
Professional focus, whole-hearted service



JZ-72577
裁布电剪刀
8" / 10"



JZ-72560
伺服电剪



JZ-72563



JZ-72562



JZ-72561
JZ-72561A 长手柄 LONGHANDLE



JZ-72564



JZ-72582



JZ-72583



JZ-72578



JZ-72579



JZ-72568



JZ-72569



JZ-72570



JZ-72571



JZ-72572



JZ-72581



JZ-90201
商标切割机
TRADEMARK
CUTTING MACHINE



JZ-72580



JZ-90200
商标切割机



JZ-72584
电子大白扣



JZ-72573



JZ-90205



JZ-90208



JZ-90209



JZ-90213



JZ-90210



JZ-90199



JZ-90211



JZ-90212



JZ-90214 贝壳装置



JZ-90202



JZ-90215



JZ-72576



JZ-90204
全自动
梭心卷线机
BOBBIN WINDER



JZ-90203
挂烫机



JZ-90301 便携剪



JZ-90302刀头

JZ-90303 电池



JZ-90304 便携剪



JZ-90306 热熔枪



JZ-90307 绕扣机



JZ-90308
气动钉扣



JZ-90309
单头分线机



JZ-90310
四头分线机



JZ-90315
充棉吹风机



JZ-90316
剪成人裤耳
Cut adult
belt buckles



JZ-90317
剪儿童裤耳
Cut belt buckles for
children's pants



JZ-90318
智能绕线器



JZ-90319
双头剪线机



JZ-90320
冷热切带机

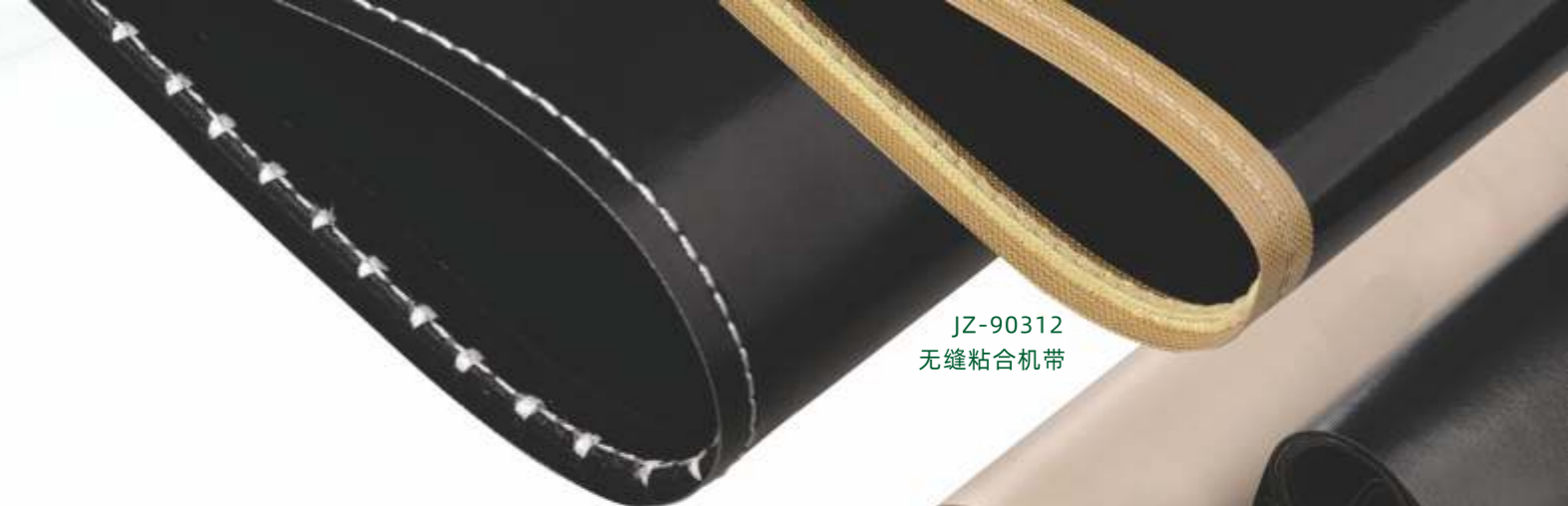

JZ-90311
带轨道粘合机带

JZ-90312
无缝粘合机带



JZ-90313
有缝粘合机带 (白)

JZ-90314
有缝粘合机带 (黑)

One-stop solution

缝配服务一站式采购

JINZEN®



JZ-90351 气动卷边筒



JZ-90352 气动型滚轮扩张装置



JZ-90353 TK刀组切带



JZ-90354 包缝机后拉滚轮



JZ-90355 绷缝机刀组



JZ-90356 气动橡津架



JZ-90357 调速器外壳



JZ-90358 停针器



JZ-90359 0303倒缝



JZ-90360 外置传感器



JZ-90361 6150切线



JZ-90362 包缝剪刀



JZ-90363 下挂式节能电机



JZ-90364 气动埋夹机切刀



JZ-90365 一体加装直驱 (顶加绕线器)



JZ-90366 包缝直驱电机



1404 4N 28X23T 22X18T
JZ-72701



1404 4N 黑胶
JZ-72702



1404 4N 黄胶
JZ-72703



1702 黄胶
JZ-72716



1702 铁齿
JZ-72717



1702 铁氟龙
JZ-72718



1412 12NN28X23T 22X18T
JZ-72704



1412 12N 黑胶
JZ-72705



1412 12N 黄胶
JZ-72706



VC008 4N 12N 尼龙
JZ-72719



VC008 4N 12N 黑胶
JZ-72720



VC008 4N 12N 黄胶
JZ-72721



1508 铁齿
JZ-72707



1508 滚花轮
JZ-72708



1412 铁齿
JZ-72709



1404 灰胶后拖轮
JZ-72747



1508 新款铁齿
JZ-72723



4412 尼龙
JZ-72724



W600 后拖轮黄胶
JZ-72710



W600 后拖轮尼龙
JZ-72711



982 拖轮
JZ-72712



青柳 25N 33N 35N 43N 后拖轮
JZ-72725

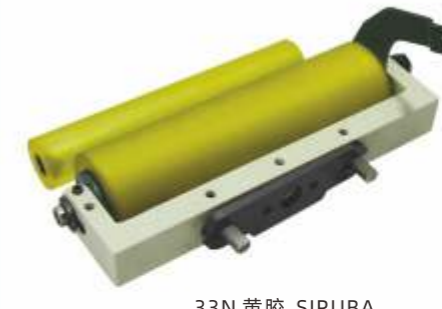

33N 黄胶 SIRUBA
JZ-72726



VC008-33N 齿后拖轮
JZ-72727



1508PR 自动转弯拖轮 铁齿
JZ-72713



1508PR 自动转弯拖轮 黄胶
JZ-72714



1508PR 上轮
JZ-72715



33N 黄胶轮 KASAI
JZ-72728



MD 前拖轮 白
JZ-72729



(6)MD 前拖轮 绿
JZ-72730



JZ-72750
4404细齿后拖轮



JZ-72748
1503橡胶后拖轮



JZ-72749
1503铁齿后拖轮



JZ-72757
35800铁齿上拖轮(于仁)



JZ-72758
35800铁齿上拖轮(重机)



JZ-72759
926铁齿上拖轮



JZ-72760
927黄胶带齿



JZ-72754
大和橡胶上拖轮



JZ-72751
4412橡胶后拖轮



JZ-72752
4412铁齿后拖轮



JZ-72769
928黄胶



JZ-72770
927黄胶



JZ-72771
927黄胶带齿



JZ-72772
927铁轮



JZ-72773
928



JZ-72774A



JZ-72774B



JZ-72775
长臂车轮子



JZ-72776
927



JZ-72763
关西33N细齿后拖轮



JZ-72755
大和橡胶下拖轮



JZ-72767
1412新款后拖轮



JZ-72753
VC008-25N橡胶后拖轮



JZ-72762
青柳33N齿后拖轮



JZ-72765
青柳50N橡胶后拖轮



JZ-72777



JZ-72756
关西33N前拖轮



JZ-72764
VC008-33N前拖轮



JZ-72768
VC008 33N 过线下拖轮组件



JZ-72766
W664 前拖轮





1404 4N 28*23T
JZ-72731



1404 4N 22*18T
JZ-72732



1404 12N 28*23T
JZ-72733



1404 12N 22*18T
JZ-72734



VC008胶轮
JZ-72735



4N黄胶轮 4N/12N
JZ-72736



VC008黄胶轮
JZ-72737



2000C后拖轮
JZ-72738



1404 4N 黑胶轮
JZ-72739



1404 12N 黑胶轮
JZ-72740



1508铁轮
JZ-72741



4404 尼龙
JZ-72742



2000C前拖轮
JZ-72743



411146双
JZ-72801



411360
JZ-72802



411364
JZ-72803



411462
JZ-72804



411146单
JZ-72805



JZ-72745



VC008前拖轮 4N
JZ-72744



W500 前拖轮组
JZ-72746



JZ-72901 GC6-1



JZ-72902 810



JZ-72903 555



JZ-72904 SINGER



JZ-72905 BR735



JZ-72906 双针



JZ-72907 5550



JZ-72908 20U

吸风装置

套装不含红色选区



JZ-89997

JZ-89998



JZ-89999 **PEGASUS EX**一体机刀组



JZ-90000 **PEGASUS EX**直驱刀组



JZ-90001 **JAMATO** AZ-6020 2109917(K2)



JZ-90006 **JAMATO** AZ-6000 2109906K1



JZ-90002 **JUKI** MO-3900 T041



JZ-90007 **JUKI** MO-2400 T035



JZ-90003 **JUKI** MO-2304 T036



JZ-90008 **JUKI** MO-3614 T042



JZ-90004 **SIRUBA** 747 VT



JZ-90009 **PEGASUS** M752 304294-91Y



JZ-90005 **PEGASUS** E32 301235



JZ-90010 **PEGASUS** E32 (35) 301030

JINZEN®

麦金缝制机械 INDUSTRIAL SEWING MACHINE

包缝机切线刀组(型号表) CHAIN CUTTER ASSEMBLY SERIES

JUKI

MODEL	TYPE	适用机型AVAILABLE MODEL
to-36	侧吸PNEUMATIC SIDECUTTER	mo-2304,2314,2404,2414
to-42		mo-3604,3614,3904,3914,6704,6714,6904,6914
ts-42		mo-3304,3314
to-22	平吸PNEUMATIC FLAT CUTTER	mo-2500
to-35		mo-2300,2400
to-41		mo-3600,3900,6700,6900
tf-35		mo-2300,2400

Jamato

MODEL	TYPE	适用机型AVAILABLE MODEL
2109917(k2)	侧吸PNEUMATIC SIDECUTTER	AZ-6020,8020
2159901(k2)		
2109906(k1)	平吸PNEUMATIC FLAT CUTTER	AZ-6000,8000
2159900(k1)		

brother

MODEL	TYPE	适用机型AVAILABLE MODEL
S24273-001	侧吸PNEUMATIC SIDECUTTER	V&N Series
S43547-001	平吸PNEUMATIC FLAT CUTTER	V&N Series

SIRUBA

MODEL	TYPE	适用机型AVAILABLE MODEL
VT	侧吸PNEUMATIC SIDECUTTER	737,747
CT	平吸PNEUMATIC FLAT CUTTER	737,747,757,767

Kingtex

MODEL	TYPE	适用机型AVAILABLE MODEL
SS-023	侧吸PNEUMATIC SIDECUTTER	SHG-6005,SHG-7005
US-027	平吸PNEUMATIC FLAT CUTTER	SH-6003,SH6004,SH-7003,SH-7004
US-035		SH-6000,SH-7000

PEGASUS

MODEL	TYPE	适用机型AVAILABLE MODEL
KS-301148(KS002)	侧吸PNEUMATIC SIDECUTTER	E52
KS-308046-91Y(KS371)		EX5204,EX5214,LX5204,LX5214
KS-304272-91Y(KS026)		M652L52
KS-304294-91Y(KS391)		M752
KH-301030(KH001)	平吸PNEUMATIC FLAT CUTTER	E32(35)
KH-301235(KH003)		E32(55)
KH-303753(KH010)		L132(35)
KH-303754(KH012)		L132(55)
KH-308020A-91Y(KH020A)		EX3200,LX3200
KH-303753A-91Y(KH016)		M632
KH-304308A-91Y(KH018A)		M732,M752
KH-308100B-91Y		EXT3200,EXT5200



成衣剪线机
THREAD TRIMMER





JZ-91481



JZ-91482



JZ-91483



JZ-91484

品牌型号对照表

切线装置	适用机型	
	品牌	型号
VF-2500	雅满桃 YAMATO	CF-2300
		VF-2500
	精机(宝狮) KINGTEX	FT-6500
		星菱 SHINGLING
	高机 K-CHANCE	VF-3500
		飞跃 FEI YUE
	中捷 ZOJE	ZJ2500A-156M-VF
	标准 TYPICAL	CK350系列
		CK-32500
	VC-2700	雅满桃 YAMATO
VC-2700M		
CC-2700		
VC-2700		
VC-2742P		
VC-3711		
精机(宝狮) KINGTEX		CT-6500
		高机 K-CHANCE
飞跃 FEI YUE		FY-2700
标准 TYPICAL		CK32700-1356D

切线装置	适用机型	
	品牌	型号
VT-1500	雅满桃 YAMATO	VT-1500(弯三本)
		VE-2713
W-600	美马 PEGASUS	W-664
		飞跃 FEI YUE
	杰克 JACK	JK-8668左修刀
		JK-8668
	宝石 GEMSY	CEM600D
CEM600A-01		
W-500	美马 PEGASUS	W-562
		W-562N
	飞跃 FEI YUE	FY31016
	杰克 JACK	JK-8568
		宝石 GEMSY
W-1500	W-1562	
W-1600	W-1664	
C007J	银箭(高林) SIRUBA	C007J
		C007JW712(新左切刀)
	通宇 PROTEX	TY-C007J
		宝石 GEMSY
	中捷 ZOJE	ZJC2500

切线装置	适用机型	
	品牌	型号
F007J	银箭(高林) SIRUBA	F007J
		飞跃 FEI YUE
	通宇 PROTEX	TY-F007J
CT-7000	精机(宝狮) KINGTEX	FT-7000
CT-9000		CT-9000
VG-888S	星菱 SHINGLING	VG-888S
VG-888A		VG-888A
MF-7723	重机 JUKI	MF-7723
MF-7823		MF-7823
RX9803	关西(森木) KANSAI SPECIAL	RX-9803
WX8803		WX8803
FW787	星锐 SHINGRAY	FW787
FW720		FW720
VG-2700	雅满桃 YAMATO	VG-3721(左切刀)
		VG-2735(右切刀)
	标准 TYPICAL	CK370D系列

JINZEN®

AUTO THREAD TRIMMER DEVICES 自动剪线组件



JZ-91500

Yamato 大和1500



JZ-91501

JZ-91502

JZ-91503

JZ-91504

JZ-91505

JZ-91506

JZ-91507

JZ-91508

JZ-91509

JZ-91510

JZ-91511

JZ-91512

JZ-91513

JZ-91514

JZ-91515

JZ-91516

JZ-91517

JZ-91518

JZ-91519

JZ-91520

JZ-91521

JZ-91522

JZ-91523

JZ-91525

JZ-91527

JZ-91524

JZ-91528

JZ-91526

JZ-91529

JZ-91530

JZ-91531

JZ-91532

Yamato
大和V2700

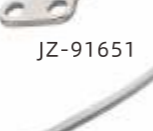
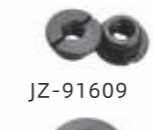
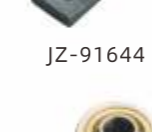
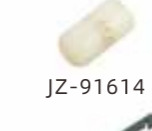
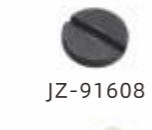
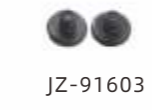

JINZEN®
AUTO THREAD TRIMMER DEVICES
自动剪线组件

PEGASUS
飞马W500



JINZEN®

AUTO THREAD TRIMMER DEVICES

自动剪线组件



JZ-91800

PEGASUS 飞马W600



SHING LING 星菱888A



JZ-91900

JZ-92000



JZ-92100

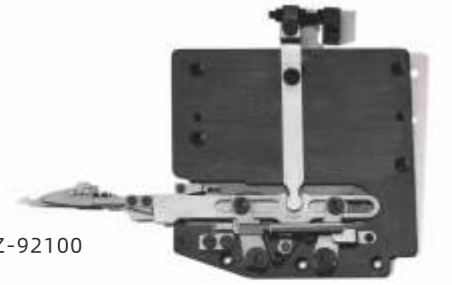

SHING LING

星菱888S



JZ-92001



JZ-92002

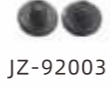

JZ-92003



JZ-92004

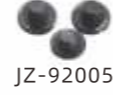

JZ-92005



JZ-92006



JZ-92007



JZ-92008



JZ-92009



JZ-92010



JZ-92012



JZ-92013



JZ-92014



JZ-92015



JZ-92016



JZ-92018



JZ-92019



JZ-92020



JZ-92021



JZ-92022



JZ-92024



JZ-92025



JZ-92026



JZ-92027



JZ-92028



JZ-92030



JZ-92031



JZ-92032



JZ-92033



JZ-92034



JZ-92036



JZ-92037



JZ-92038



JZ-92039



JZ-92040



JZ-92042



JZ-92043



JZ-92044



JZ-92045



JZ-92046



JZ-92048



JZ-92049



JZ-92050



JZ-92051



JZ-92052



JZ-92053



JZ-92059



JZ-92060



JZ-92063

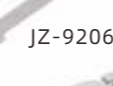

JZ-92064



JZ-92054



JZ-92059

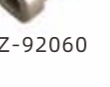

JZ-92060



JZ-92063



JZ-92064

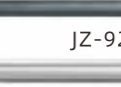

JZ-92056



JZ-92059



JZ-92060



JZ-92063



JZ-92064



JZ-92057



JZ-92059



JZ-92060



JZ-92063

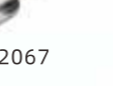

JZ-92064



JZ-92058



JZ-92059



JZ-92060



JZ-92063



JZ-92064

XINGRUI

星锐787



JZ-92101

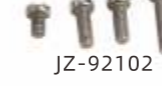

JZ-92102

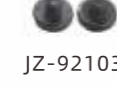

JZ-92103



JZ-92104



JZ-92105



JZ-92106



JZ-92107



JZ-92108



JZ-92109



JZ-92110



JZ-92112



JZ-92113



JZ-92114



JZ-92115



JZ-92116



JZ-92118



JZ-92119



JZ-92120



JZ-92121



JZ-92122



JZ-92124



JZ-92125



JZ-92126



JZ-92127



JZ-92128

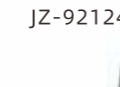

JZ-92130

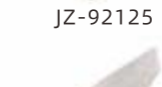

JZ-92131



JZ-92132



JZ-92133



JZ-92134

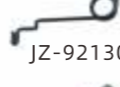

JZ-92136



JZ-92137

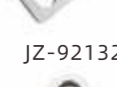

JZ-92138



JZ-92139



JZ-92140



JZ-92142



JZ-92143



JZ-92144



JZ-92145



JZ-92146



JZ-92148



JZ-92149



JZ-92150



JZ-92151



JZ-92152



JZ-92153

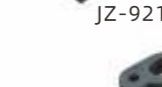

JZ-92159



JZ-92160



JZ-92162



JZ-92164



JZ-92154



JZ-92158



JZ-92163

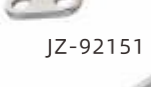

JZ-92165

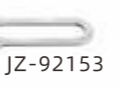

JZ-92155



JZ-92159



JZ-92161



JZ-92166

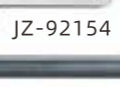

JZ-92156

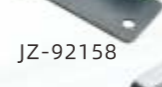

JZ-92159



JZ-92162

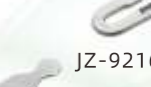

JZ-92167

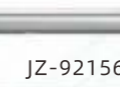

JZ-92157



JZ-92159



JZ-92163



JZ-92168

JINZEN®

AUTO THREAD TRIMMER DEVICES
自动剪线组件

Kingtex

宝狮CT6500



针织裤头松紧带车缝

(简易膝动式)

KNIT ELASTIC WAIST BAND ATTACHING
(MANUAL TYPE)

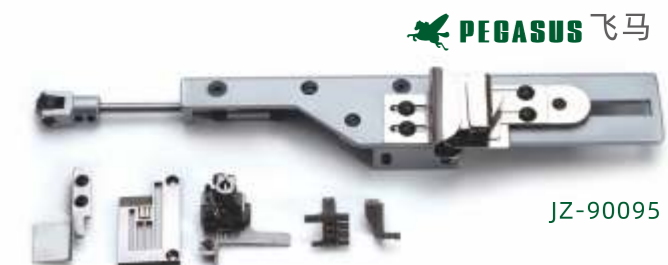



Puller attachment

拖轮系列产品

拖轮系列产品 Puller Attachment

JZ-HPL 單針、雙針車用 一般布料型
FOR SINGLE OR TWIN NEEDLE (General material)



L×W×H:615×374×238mm

具有多種選擇性拖輪 能適應不同質料之車縫。
With various optional rollers for different kinds of sewn materials.

下有滾軸底盤與拖輪上下滾動，使布料移動更加順暢。
The roller could roll with the rolling-plate, cloth can be moved more smooth.

滾輪尺寸：直徑55mm，寬度15/35/55mm
Roller: Diameter 55mm, Width 15/35/55mm



JZ-HPS 小輪、單針、雙針車用 (薄物短距型)
FOR SMALL ROLLER SINGLE OR TWIN NEEDLE Short thin material



L×W×H:615×374×238mm

拖輪與車針距離超近，適合薄物，短距離及彎弧車縫。

Extremely close pulling facilitates curve and short sewing on thin materials

滾輪尺寸：直徑25mm，寬度15mm
Roller Diameter 25mm, Width 15mm



JZ-HPZ-380 鏈目縫車專用型
FOR SPECIFIC FLAT BED CHAINSTITCH



L×W×H:615×374×238mm

縫制西裝褲專用，例如JUKI-380
For sewing career/dress pants, EX: JUKI-380
滾輪尺寸：直徑55mm，寬度15、35、55mm
Roller: Diameter 55mm, Width 15/35/55mm



JZ-HPL-S1 飾縫車用 (一般布料型) FOR FLAT BED COVERSTITCH (General material)



L×W×H:615×374×238mm

滾輪尺寸: 直徑55mm,
寬度15/35/50mm
Roller: Diameter55mm,
width15/35/50mm

JZ-HPT 單針、雙針車用, 上下輪驅動 (加強型) FOR SINGLE OR TWIN NEEDLE WITH UPPER AND LOWER ROLLER (strengthened type)



L×W×H:615×374×238mm

上下輪同時驅動 拉力特強 縫制順暢
Powerful upper and lower rollers drive

適合薄至極厚物 長距離車縫
For thin to heavy material

上輪 直徑55mm 寬度15/35/50mm
下輪 直徑27mm 寬度60mm
Upper roller: Diameter55mm,width15/35/50mm
Lower roller: Diameter27mm,width60mm

JZ-HPL-S2 筒型飾縫車用 一般布料型 FOR CYLINDER BED COVERSTITCH (General material)



L×W×H:615×374×238mm

附專用基座及下輪
Special bracker and lower roller

上輪 直徑55mm,寬度15/35/50mm
下輪 直徑27mm,寬度60mm
Upper roller:Diameter55mm,width15/35/50mm
Lower roller:Diameter27mm,width60mm



JZ-HPK 包縫車用 上下輪驅動 薄至厚物長距型 FOR OVERLOCK WITH UPPER AND LOWER ROLLER (Thin to very thick material)

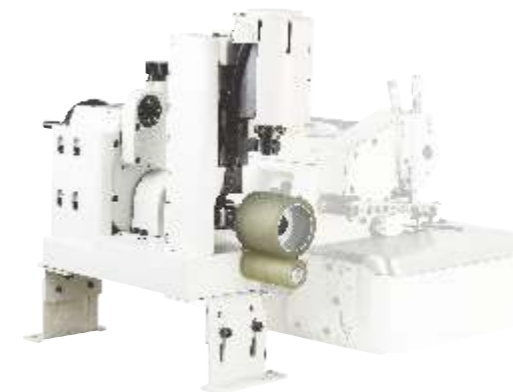

L×W×H:615×374×238mm

適用於薄至極厚物的直綫縫制
Suitable for thin to extremaly thick materials in
straight sewing

上輪 直徑55mm 寬度15/35/50mm
下輪 直徑27mm 寬度60mm
Upper roller: Diameter55mm,width15/35/50mm
Lower roller:Diameter27mm,width60mm

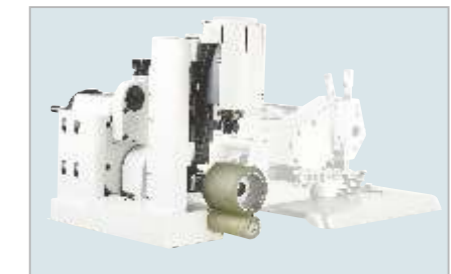

下沈式 Submerged type

JZ-HPF 腕型車用, 皮帶式拖輪 極厚物型 FOR FEED-OFF-ARM (Belt puller for heavy to extremely heavy material)



L×W×H:615×374×238mm

皮帶式拖輪, 拉力特強。
Belt puller for powerful pulling strength

皮帶寬帶: 19mm
Belt width: 19mm



JZ-HPK-SP 前拉式 (意大利面專用) FRONT PULLER (Special for spaghetti)



L×W×H:615×374×238mm

上輪 直徑55mm 寬度15/35/50mm
下輪 直徑27mm 寬度60mm
Upper roller: Diameter55mm,width15/35/50mm
Lower roller:Diameter27mm,width60mm

JZ-HCS 袖口縫制鋪助裝置(筒型車適用, 如JUKI DSC-246、金輪CS 8703)
Rear Puller with Pneumatic roller tensioner(For Cylinder-Bed machines, such as JUKI DSC-246 Golden-Wheel CS-8703)



LxWxH:450x274x193mm

以滑輪式的氣動裝置(附壓力表)可配合袖口、褲管等物料之不同大小可調節自如, 并因滾輪軸之固定作用使縫制作業更為輕鬆, 能有效減少不良品的消耗近而提高產能。
The roller tensioner is governed by air gauge thus the tension as well as the tubular circumference of different material can be adjusted easily to increase productivity and reduce waste.



搭配拉布輪組
To be used with rear puller

滾軸行程最小範圍3英寸
Minimum tubular circumference is 3" (75mm)



可不加裝拖輪組
Rear puller is eliminated

滾軸行程最大範圍6英寸
Maximum tubular circumference is 6" (150mm)

JZ-HPF-HB/PCV/AF

厚物·極厚物用皮帶式拖輪
BELT PULLER FOR HEAVY TO EXTREMELY HEAVY DUTY MATERIAL



氣動式自動切線裝置(一般腕型車用)
Chain cutter for Off-the-Arm



氣動式自動切線裝置(四針六線車用)
Chain cutter for 4 NEEDLE / 6THREAD Feed-Off-the-Arm



AF 氣壓式壓腳裝置
(一般腕型車用)

PNEUMATIC PRESSURE FOOT (FOR FEED-OFF-THE-ARM)



JZ-HPB 褲頭車用 上下輪驅動 厚物型
FOR SPECIFIC WAISYBAND WITH UPPER AND LOWER ROLLER(Heavy duty)



強力驅動, 可防止針目大小不一
Powerful driver making equal stitches.

適用於牛仔布等厚物

Suitable for heavy material. ex: jeans



JZ-HPG 包縫車用·小輪(薄物用)
FOR OVERLOCK WITH SMALL ROLLER (For thin material)



LxWxH: 365x365x300 mm

本拖輪不能裝在附有水平或垂直式自動切線裝置的包縫車上
This puller unable to install onto overlock machine with either vertical or horizontal automatic thread-chain cutter.

HPG系列所需要的基本空間

Space Limitation For HPG Series:

JUKI MO 3000,6000	SERIES
PEGASUS EX.MX.M	SERIES
BROTHER N,V	SERIES
YAMATO AZ 8000,6000	SERIES
SIRUBA 757H	SERIES



JZ-HPY

單針·雙針車用, 上下輪驅動
FOR SINGLE OR TWIN NEEDLE WITH UPPER AND LOWER ROLLER



LxWxH:615x374x238 mm N.W./G.W.: 9 / 10 kgs

JZ-HPY-C

飾縫車用
FOR COVERSTITCH



LxWxH:615x374x238 mm N.W./G.W.: 9 / 10 kgs

JZ-HPY-SP

前拉式(意大利麵專用)
FRONT PULLER (For spaghetti sewing)



LxWxH:615x374x238 mm N.W./G.W.: 9 / 10 kg

JZ-HPR

包縫車用·皮帶後送(薄物用)
FOR OVERLOCK WITH REAR DRIVE BELT (For thin material)



不受空間限制, 各種廠牌機型均可安裝。
Suitable for every machine without space limitation.
獨特設計, 皮帶與車針距離超近
Close proximity of rear drive belt and needle improves sewing performance.
適用於柔軟光滑、易皺的薄物
Suitable for silky and easy-pucker thin materials.



JZ-HMDK-61

包縫車專用型(基座固定于機頭上方)
FOR SPECIFIC OVERLOCK
(Base is mouted on the machine head)



送帶寬度Feeding:50mm
L×W×H:450×274×193mm

JZ-HMDK-60

包縫車專用型(基座固定在車板上)
FOR SPECIFIC OVERLOCK (Base is mouted on the table)



送帶寬度Feeding:50mm
L×W×H:450×274×193mm

JZ-HTFU-600

上送型送料機(一至三條)
UPPER TAPE FEEDER (1-3LINES)

專為縫制運動衣褲之三點條而研發
Specially developed for sportswear with 3
tapers striped
三組馬達獨立運行
Three sets of motors operate Independently
可同時送料一至三條
At the same time feeding 1-3 lines
固定架式,各機種均適用
Fixed frame.All models are applicable

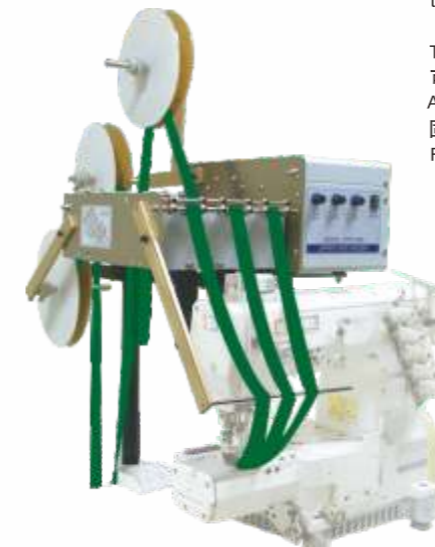

送帶寬度
Feeding width : 40mm

L×W×H:510×420×255mm

JZ-HTFU-202A

電動型防止打結裝置
UNTANGLING MOTOR DEVICE



LxWxH: 365x365x300 mm

旋轉式能更有效的防止鬆緊帶打結與纏繞
To by the Rotational motion, effectively to
untanglethe twisted or gathered elastic tape.

JZ-HMDL-31

千鳥車專用型(基座固定于機頭上方)
FOR SPECIFIC ZIG-ZG
(Base is mouted on the machine head)



送帶寬度Feeding:50mm
L×W×H:450×274×193mm



送帶裝置位置較低。
Metering device position low

JZ-HMDL-30

千鳥車專用型(基座固定于車板上)
FOR SPECIFIC ZIG-ZG
(Base is mouted on the table.)



送帶寬度Feeding:50mm
L×W×H:450×274×193mm



JZ-HTFU-200

上送型送料機(送料寬度70mm)
UPPER TAPE FEEDER(Feeding width 70mm)

JZ-HTFU-200-8

上送型送料機(送料寬度200mm)
UPPER TAPE FEEDER(Feeding width 200mm)



L×W×H:325×365×200mm
L×W×H:450×274×193mm

JZ-HTFS-230

側送型送料機(送料寬度70mm)
SIDE TAPE FEEDER(Feeding width 70mm)

JZ-HTFS-230-8

側送型送料機(送料寬度200mm)
SIDE TAPE FEEDER(Feeding width 200mm)

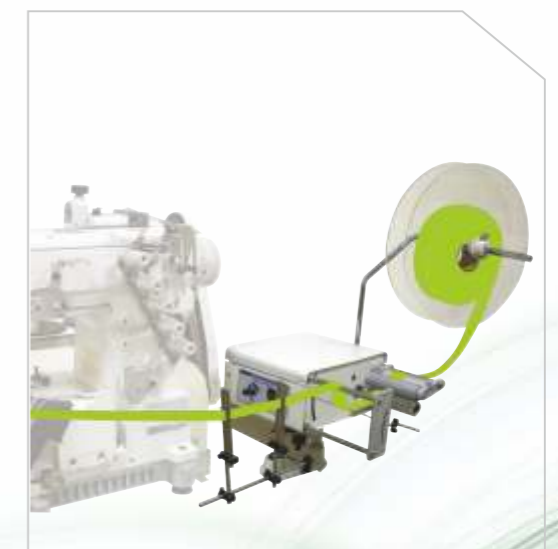

L×W×H:325×365×200mm
L×W×H:450×274×193mm

JZ-HCT-888

微電腦全方位送帶機
VERSATILITY TENSION TYPE COMPUTERIZED METERING DEVICE



LxWxH: 450x300x250 mm



安裝於皮帶輪端的計數器，
可計算車縫針數(選擇配件)
Fits on the machines hand
wheel to control automatic
section changes (Optional parts).



無張力開關(標準配件)
Free Tape Function Switch.
(Standard)



LED+手動換段(選擇配件)
LED and manual section
changes. (Optional parts)



膝動換段開關(標準配件):
工程換段用
Knee Switch(Standard):
For manual sectionchanges.

JZ-HCT-888U

微電腦送料機
TENSION TYPE COMPUTERIZED METERING DEVICE



LxWxH: 450x300x250 mm

微電腦送料機專為車縫鬆緊帶而研發，控制盒液晶顯示操控，簡易設定，操作隨心所欲，鬆緊帶平順，是縫製內衣褲的最佳利器！

Tension type computerized metering device specialized in sewing the elastic tape, LCD display control box, easy setup, easy operation, arbitrary, increase your productivity, This the best tool for Manufacturing underwear!

JZ-HCP-520

直驅式電子平車拖輪
PULLER WITH DIRECT-DRIVING COMPUTERIZED



LxWxH: 365x365x300 mm



JZ-HCP-530

直驅式電子平車拖輪
PULLER WITH DIRECT-DRIVING COMPUTERIZED



Power: 110V~240V, 50/60Hz

可與車針同步，縫針不易斷裂。
Simultaneous speed, the needle is unbreakable.
智慧型拖輪，可調針目大小。
Smart puller, adjusted distance.
倒針時，拖輪同時反方向轉動，免提起拖輪，減低噪音。
Puller can be pull back when reverse sewing.
多機種皆適用，如：平車、三本車、人字車、埋夾車、包縫車。
Many models are applicable.



JZ-HCT-E9U-M

微电脑全方位送松紧带送带机系列产品/
上送型/荧幕操控
TENSION TYPE COMPUTERIZED METERING DEVICE-UPPER
FEEDING-MONITOR OPERATION



JZ-HCT-E9S-M

微电脑全方位送松紧带送带机系列产品/
侧送型/荧幕操控
TENSION TYPE COMPUTERIZED METERING DEVICE-SIDE
FEEDING-MONITOR OPERATION



JZ-HCT-E9B-M

微电脑全方位送松紧带送带机系列产品/
下送型/荧幕操控
TENSION TYPE COMPUTERIZED METERING DEVICE
-BOTTOM FEEDING-MONITOR OPERATION



JZ-HCT-E9U-C

微电脑全方位送松紧带送带机系列产品
TENSION TYPE COMPUTERIZED METERING DEVICE



JZ-HMCA-18K-38/TR

拷克车用, 附自动切带及送带装置
FOR OVERLOCK WITH AUTO CUTTING AND
RE-INSERT



JZ-HCT-S6C

饰缝车用
FOR COVERSTITCH



JZ-HCT-S6B

饰缝车用-下送
FOR COVERSTITCH-FROM
BOTTOM FEEDING



JZ-HCT-S6S

饰缝车用-侧送
FOR COVERSTITCH-FROM
SIDE FEEDING



JZ-HCT-S6Z-B

人字车-下送
FOR ZIGZAG-FROM BOTTOM
FEEDING



JZ-HCP-3815 单、双针车用
FOR SINGLE OR TWIN NEEDLE



JZ-HCP-3815-C 饰缝车用
FOR COVERSTITCH



JZ-HCP-E 四针六线用
FOR 4-NEEDLE 6-THREAD FEED-OFF-THE
-ARM INTERLOCK FLATSEAMING MACHINE



JZ-HCB 适合自动缝制, 前送后拉
SUITABLE FOR AUTOMATIC SEWING
FRONT FEEDING AND BACK PULLING



- 可与针车同步, 缝针不易断裂, 可调针目大小
Simultaneous speed, the needle is unbreakable, pitch is adjustable.
- 倒针时, 拖轮可同时反向转动, 免提起拖轮
When reverse sewing, puller can pull back at the same time, it doesn't need to lift puller.
- 体积小, 方便安装, 直驱式平车皆可安装
Compact size, easy to install, for lockstitch with direct-driving motor.

JZ-HCP-H 适合全方位电子平车拖轮
FOR VERSATILE PULLER WITH DIRECT-DRIVING



- 活动式支架, 可直接移动拖轮
Movable Stand, it can move the puller directly.
- 皮带宽度:
Belt Width
17MM
- 液晶显示盒, 可调整针距最大到12MM
LCD: Adjustable
Pitch, Maximum
:12MM

闸刀式可自动/半自动前后切刀装置 PNEUMATIC GUILLOTINE AUTO/MANUAL CUTTER

JZ-HTA-F 埋夹车/曲手车用
FOR FEED-OFF-THE-ARM

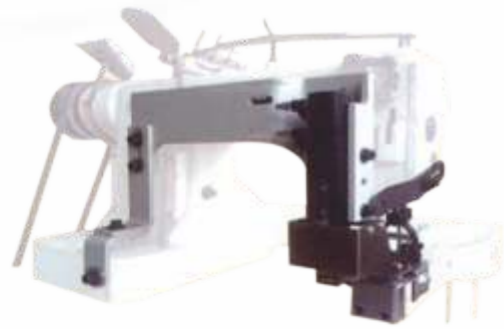

JZ-HTA-E 四针六线用
FOR 4-NEEDLE 6-THREAD FEED-OFF-THE-ARM INTERLOCK FLATSEAMING MACHINE

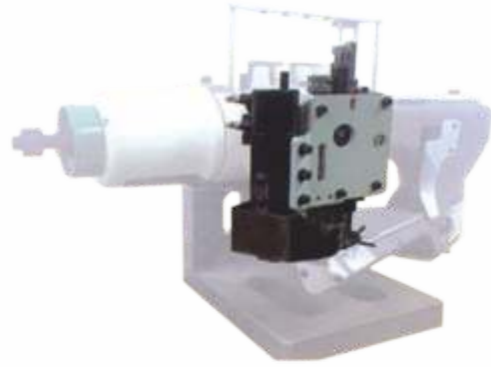

JZ-HTA-C 多针车用
FOR MULTI-NEEDLE SEWING MACHINE

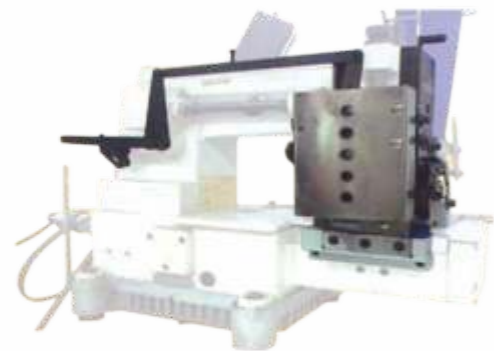

JZ-HTA-L 单、双针车用
FOR SINGLE OR TWIN NEEDLE



JZ-HTCM-L50 触带式切带装置
MANUAL CUTTING DEVICE

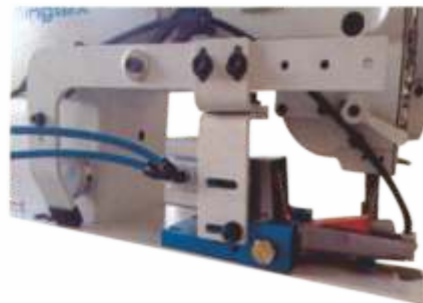

JZ-HTCA-L50 光电感应切带装置
PHOTO-SENSOR CUTTING DEVICE



闸刀式空间大更方便缝制

THE GUILLOTINE-TYPE SPACE IS MORE CONVENIENT TO SEW

JINZEN®

JZ-HST-L/HTFU-600/HTA-C

自动收衫机

- 含送料机
- 含闸刀式切刀装置

Automatic Material Receiving Machine

- with Tape Feeder
- with Cutter Device

- 用途: 收集西装裤, 衣服...等或压烫裁布
Application: Stacking for pants, shirts, suit...etc.
- 收集长度: 裁片由20公分~120公分均可
Stackin Length: Cloth pieces from 20cm to 120cm
- 可计算件数: Quantity can calculate
- 动作示意图Procedures:



JZ-HST-M/HTFU-600/HTA-C

自动收衫机/送料机/闸刀式切刀装置
Stacker/Feeder/Cutter



- 控制箱: 设定切带长度及计算件数
Control Box: TO set length of tape cutting and calculate quantity.



- 附切刀装置
With cutting assembly



- 裁片尺寸: 10-70公分
Stacker Length: from 10cm to 70cm

JZ-HCR

自动输送带
AUTOMATIC CONVEYOR



标准尺寸standrad size:

尺寸SIZE	L850*W400MM
转速RPM	0~400 RPM



● 编码器，与针车同步车缝
Synchronizer



● LCD panel-可调整速度跟上针车速度
Adjustable speed

● 输送带材质可选择齿面与平面
Conveyor belt material can
Select tooth surface and plan

● 安装于车板上，安装简易，适合大件布料，例如窗帘、床罩、凉被、蚊帐...可配合针车速度同步车缝，令车缝人员轻松缝制而增加效率，提升产能。

Installed on the table,easy to install suitable for large fabrics,such as:
Curtains, bedspreads,mosqutio nets....
Synchronized with the speed of sewing machine.
Increase efficiency,improve production capacity.

● 特殊规格接受订货生产
Special specification availabel for sustiom-made



JZ-FSP-9800

全自动服装包装机
AUTOMATIC PACKAGE
MACHINE FOR GARMENT

- 全自动服装包装机，高速完成折叠，入袋，封装，堆叠动作
Automatic garment packaging machine,folding at high
Speed,bagging,sealing,stacking action.
- 适用衣物：T-shirt,POLO衫，夹克，裤子...
Applicable clothing: t-shirt,polo shirt ,jacket,pants...
- 一人一机，减少人力成本
1 person,one machine,reducing labor costs



JZ-SC-7

全自动包装机
AUTOMATIC BAGGING AND SEALING MACHINE

- 封装方式:热熔或贴胶纸
Packing method:hot melt or adhesive tape



JZ-FD-980

全自动折衣机
AUTOMATIC FOLDING MACHINE

JZ-T-1

间歇性变速器
Intermittent Transmissin

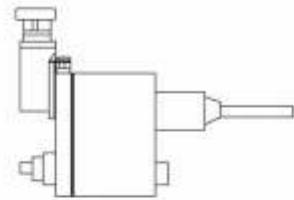

標準品 單位: mm
Standard Type Unit: mm

機型 Type	a	b	C
S-1	9	65	24
	9	82	38
T-1	9	68	24
	30	98	24
T-2	115	165	24



機型 Model	S-1	T-1	T-2
入力軸轉數(最高) Input Shaft RPM(MAX. SPEED)	2000	3000	3000
出力軸轉數(最高) Output Shaft (MAX. SPEED)	430	225	450
扭力 (Kg/cm) Torque (kg/cm)	12	15	15
重量 (kgs) Weight	2	2	2

滾轮规格表 Specification list

輪子尺寸 Roller Sizes

D 直徑 Diameter	W 寬度 Width	
上輪 Upper Roller	25	10
	27	13
	38	15
	55	15,35,50
下輪 Lower roller	25	60
	27	60

材質 Material			
S 鐵齒面 Steel Teeth		T 塑膠齒面 Plastic Teeth	
D	W	D	W
55	15	27	60
55	50	55	50

輪子 Roller



輪子材質與外型 Roller material and figures

代號 Code	P	S	T
材質 Material	Pu平面 Polyurethane Plain	鐵齒面 Steel Teeth	塑膠齒面 Plastic Teeth
外型 Figure			



JZ-HCT-E9B-M

ELECTRONIC-CONTROL
DUST COLLECTING
电控集尘组件



CERAMIC BLADE
陶瓷刀片



使用防鸟巢装置前
before using anti bird nest device



使用防鸟巢装置后
after using anti bird nest device



SIDE TYPE
MMER ASSEMBLY
斜拉款剪线刀组



JZ-HCT-E9B-M

ANTI BIRD NEST DEVICE FOR
COMPUTERIZED LOCKSTITCH
SEWING MACHINE

电脑平缝机防鸟巢装置



企业核心价值观

正能量
凝聚力
战斗力
敢创新
懂感恩

品牌核心价值观

专业，丰富，高效

Enterprise core values

positive energy
cohesion
combat effectiveness
dare to innovate
full of gratitude

brand core values

professional, abundant, efficient

成长理念

积极成长，成就美好未来
消极学习，自弃锦绣前程

工作理念

认真专注中缔造完美细节
激情投入间尽显生命尊严

营销理念

以解决客户问题为第一原则
以实现双方共赢为核心思想

服务理念

兑现客户意料之中的每个承诺
实现客户意料之外的更多需求

品质理念

在精挑细选中永记质量生命
在环环把控中铸就非凡品质

用人理念

勤奋踏实者赋予更多机会
勇于担当者委以更多重任

执行理念

不偏差，不拖延，不放弃

GROWING PHILOSOPHY

Aggressively growth achieves your bright future
Lazy learning ruins your bright future

WORK PHILOSOPHY

Perfect details root from earnest and concentration
The dignity of life was reflected in hard work

MARKETING PHILOSOPHY

Regard solving customers' problems as the first principle
Consider win win situation as the core idea

SERVICE PHILOSOPHY

Keep every promise we made to customers
Bring in more surprises to customers

QUALITY PHILOSOPHY

Focus on quality when sifting products
Make top-quality products for focusing on each process

STAFFING PHILOSOPHY

Provide more chances for diligent and surefooted people
Give more important tasks to the people with responsibilities

IMPLEMENT PHILOSOPHY

No deviation, no delay, never give up





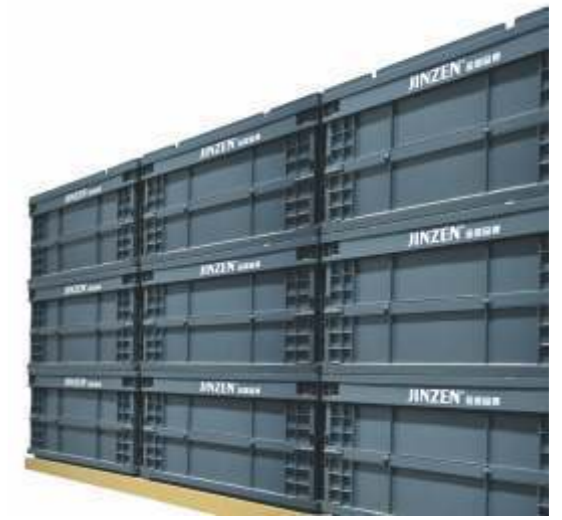

智能仓储 Intelligent storage

JINZEN®

Stand the test of good quality
好品质经得起考验

金振企业历经缝配行业20年的专注与投入；
Sewing field, 20 years' concentration and commitment,

金振品牌12年的铸造与辉煌；
JINZEN brand, 12 years' casting and resplendence,

产品几百种到50000余种的跨越；
Products' extending from hundreds to 50000

全球累计3000余家的客户见证；
More than 3000 customers' witness and ratification ,

产品服务已远销50多个国家和地区；
Products and services covered 50 countries and regions,

百名以上专业精英团队用心服务；
Hundreds' elite group serves diligently,

500家高端合作伙伴的联手打造；
Sincere cooperation with 500 excellent partners,

10多个附加流程的品质绝对保障；
10 more additional processes to gauntree the quality.





SINCERE DESIRE

道正信诚是金振人的立业之本；
明德修身是金振人的必具素养！

CEO:

胡小青
Erica



微信公众号: JINZENCHINA



JINZEN®

JINZEN brand include 8 series products, especially in JINZEN hook, bobbin, bobbin case; JINZEN knife; JINZEN needle plate, foot dog; JINZEN looper; JINZEN folder; JINZEN tools; which supported by powerful factories and advanced technology, strict inspection processes, and have won high praise from customers for rich products, Excellent quality and reasonable price. JINZEN people regard "positive energy; cohesion; combat effectiveness; dare to innovate; full of gratitude" as the core values of team, with "To be the benchmark enterprise in the global sewing machine parts field" as the corporate vision, go to meet new and continuous challenges with "try all our best for making JINZEN BRAND to be the synonym of quality in the international stage" as the great mission. JINZEN received many honors over the years, based on JINZEN people's diligence and hard work, we are confident about the future, and will march forward bravely; Let's look forward to JINZEN's brilliant tomorrow.

公司以JINZEN为品牌建立了以JINZEN旋梭、梭壳、梭心; JINZEN针板、送布牙、压脚; JINZEN刀具; JINZEN弯针; JINZEN卷边筒; JINZEN剪刀; JINZEN工具; 以及JINZEN内部配件为主导的八大系列产品, 拥有强大的工厂后盾和先进的技术支持, 以及严格的检测管控流程, 以品种齐全, 品质优良, 物超所值深得客户的高度评价。

金振人正以“正能量、凝聚力、战斗力、勇创新、懂感恩”为团队核心价值观; 以“成为全球缝配领域的标杆企业”为愿景; 以“为金振品牌在国际舞台成为品质的代名词而倾尽全力”为伟大使命的追求下不断挑战。

多年来金振企业获得的一切荣誉无不体现了金振人的勤奋与努力, 面对未来, 我们将更加的信心满满, 勇往直前; 让我们共同期待金振企业的美好明天!



Signature



message
from the chairman

总裁寄语

金振人以严谨、高效、
负责任的企业精神，
站在客户的立场上，
追求着产品的创新，
不断拼搏，
创造无限可能……

掌舵人：

蔡飞扬

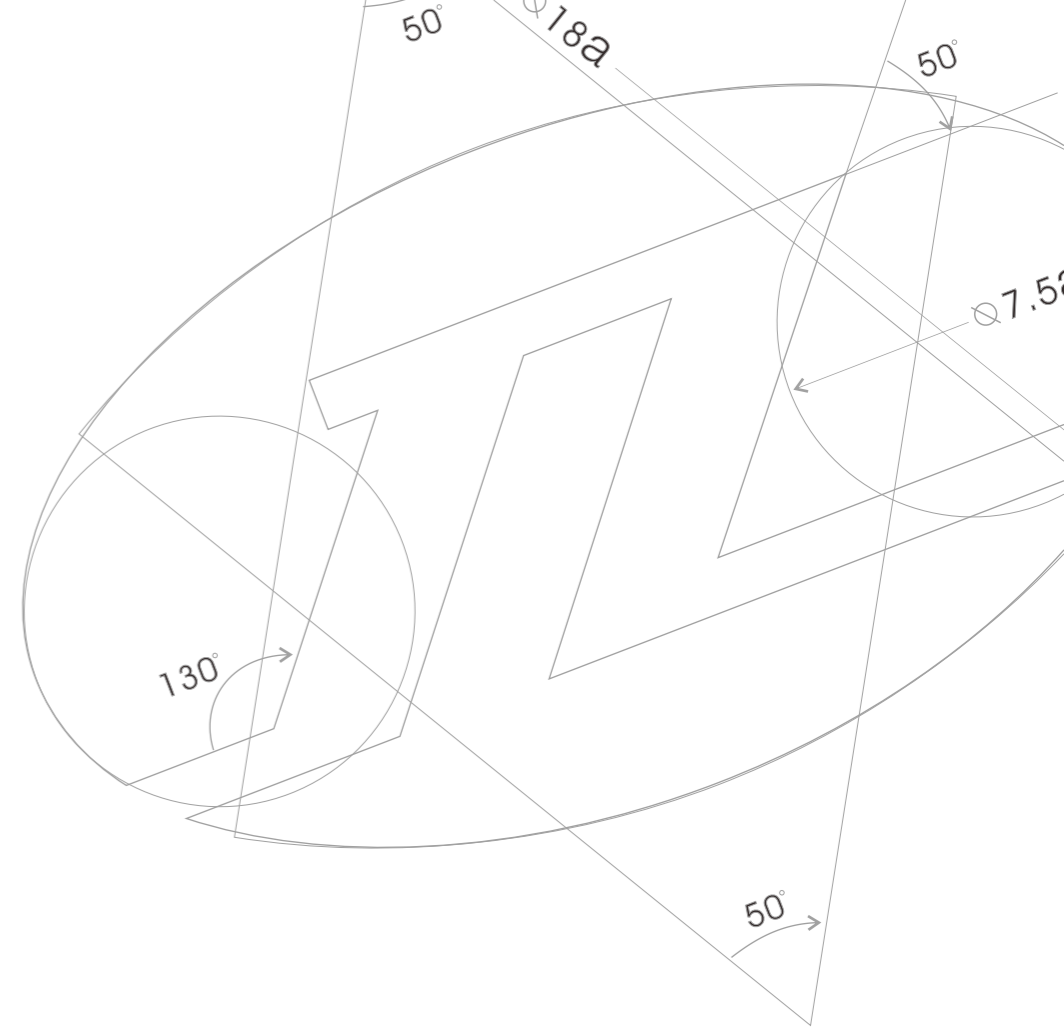

JINZEN®

The logos of JinZen combine with the first-writing alphabet letters "J", "Z". The outside shape depicts the outline of the earth, it contains all peoples on five continents live together in harmony; with the green background, means "environmental protection, vitality and harmony". Generally speaking JinZen set up a bridge towards to the world then make a communication, cooperation and trade for each other .but also contains JinZen linked the friends together tightly! 金振品牌LOGO是由金振拼音首个大写字母J、Z组合而成，椭圆形的外观抽象为地球，以绿色为主导，寓意着环保、生机、和谐。JZ像似金振人架起的一座沟通世界，走向世界，与其交流、合作、贸易的桥梁，同时象征着将世界各国人民紧紧的系在了一起!

JinZen concept: work hard for make consummate machine, make effectiveness to creating beauty!

为缝纫全人类之衣经纪，为创造可天下之美效力!

使命 / Mission:

为金振品牌在国际舞台成为品质的代名词而倾尽全力
try all our best for making JINZEN BRAND to be the synonym
of quality in the international stage.

使命宣言 / Mission statement:

为同仁创造快乐的氛围与广阔的事业平台
Create a fun environment and extensive career platform for colleagues

为客户提供系统的服务与绝对的品质保障
Provide the systematic service and unconditional quality assurance for customers

为社会打造积极的环境与优质的品牌形象
Create a positive environment and superior brand image for society

为股东带来持续的收益与无限的精神追求
To bring in revenues for shareholders, also infinitely spiritual pursuit



2005

第一本穿线胶装的
70p彩色印刷画册，
于上海光大展览馆发布。



2006

第二本穿线胶装的
130p彩色印刷画册，
于上海新国际博览中心发布。



2007

成立金振进出口有限公司，
拥有自营进出口权，
导入VI视觉识别系统，
以全新的184P画册版面设计
向国家版权局递交申请保护，
发布上海新国际博览中心。
版权号:2009-L-00021791



2009

向金振VIP客户赠送采用
精装成册的新版284P画册，
发布上海新国际博览中心。
版权号:2009-L-00021792



2011

全新升级后的372p新版画册，
发布上海新国际博览中心。
版权号:2013-L-00094541



2013

提升视觉形象设计，
以全球服务商定位为基准，
画册408p，
发布上海新国际博览中心。
版权号:2015-L-00236843



2015

汇总升级后的新版画册，
436p，更加全面和快捷
发布上海新国际博览中心。
版权号:2015-L-00236844



2017

企业30+周年刊
回顾金振品牌历史
诠释产品完美品质，
画册84p，
发布上海新国际博览中心。

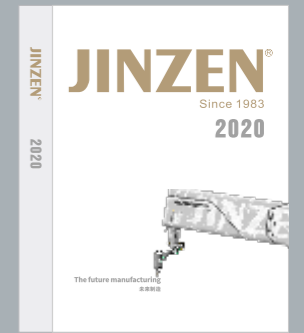

2019

世纪力作，完善产品目录
提升服务全球代理商
画册424p，
发布上海新国际博览中心。
版权号:已递交国家版权局



1997

第一份黑白胶印印刷折页，
于上海光大展览馆发布。



2000

第一份由人民照相馆摄影拍照，
印刷彩色印刷折页，
于上海光大展览馆发布。



2003

第一本骑马钉装订成册的
彩色印刷画册，
于上海光大展览馆发布。

我们的成长史
Our Growth history



CISMA 2019

2019中国国际缝制设备展览会
上海新国际博览中心
2019年9月25日-28日

E7馆-M15
WELCOME TO JINZEN

2008版权证书 证书号:00021791



2012版权证书 证书号:00094541



2010版权证书 证书号:00021792



2014版权证书 证书号:00236843



2016版权证书 证书号:0000236844



2020版
本版本已递交国家版权局申请登记。

JINZEN[®]
Since 1983

版权声明：

- 1.本画册中所有设计版面及效果已向国家版权局登记，受法律保护。
- 2.画册中产品包装已申请专利，
- 3.画册中涉及到的金振系列商标，均属于金振公司所有，请勿仿冒！



以上知识产权未经允许，任何单位和个人不得刊登、转载，扫描或以其它方式使用上述作品